

VS2

Montage- und Bedienanleitung

*Assembly and operating instructions
Notice de montage et mode d'emploi*

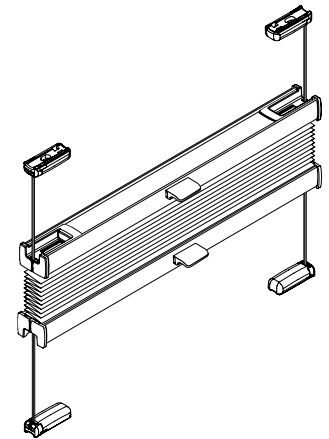

02 / 2021

technische Änderungen bleiben
vorbehalten

*subject to technical change
sous réserve de modifications techniques*



04046046444558

A Montage

Fixation – Montage

→ **Bitte nur beiliegende Schrauben verwenden!**

Please use only the enclosed screws! – Veuillez utiliser seulement les vis jointes!

SPANNSCHUH

TENSION CORD BRACKET – SUPPORT DE CÂBLES

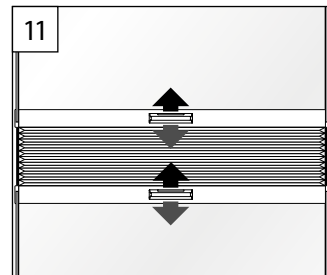
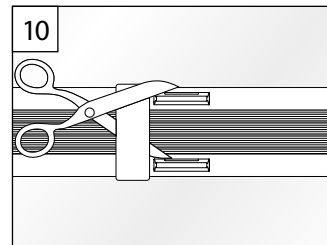
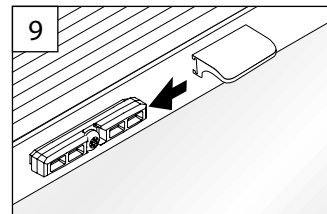
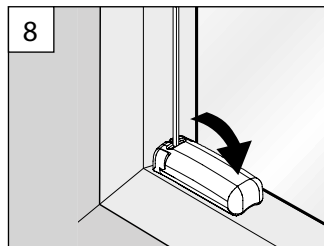
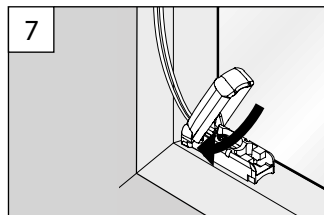
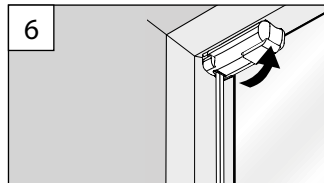
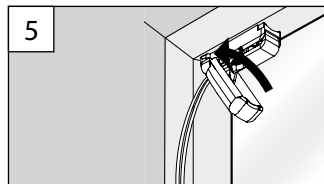
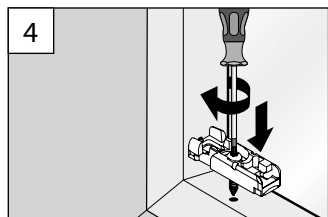
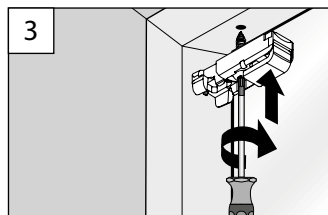
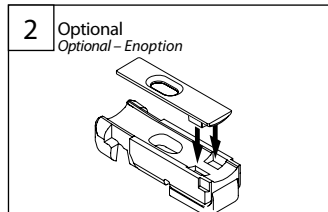
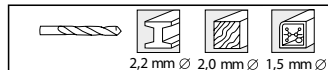
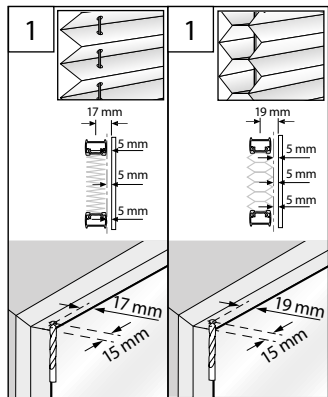
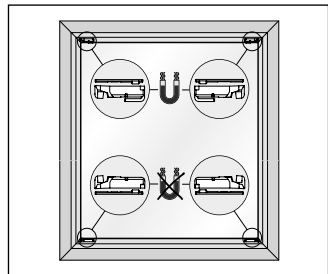

WANDWINKEL

WALL FIXING BRACKET - SUPPORT MURAL

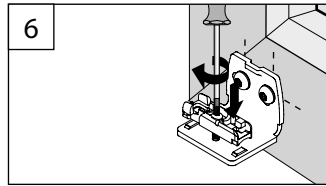
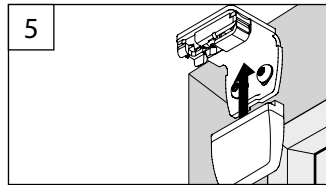
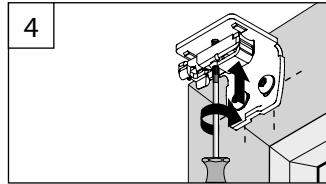
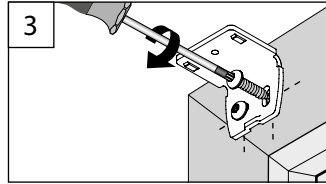
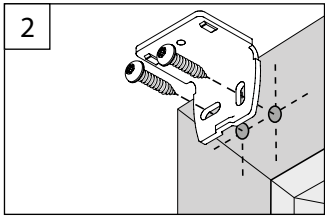
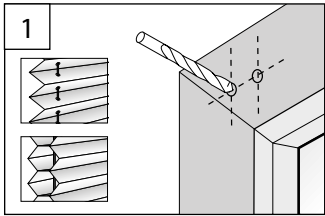
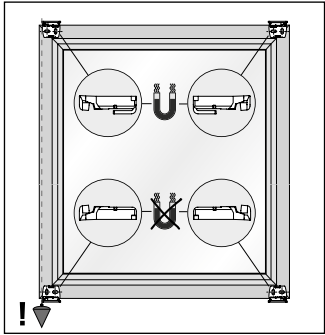

3

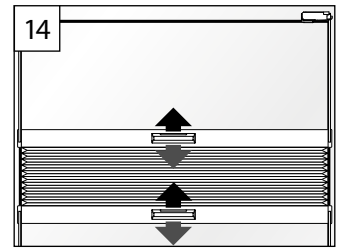
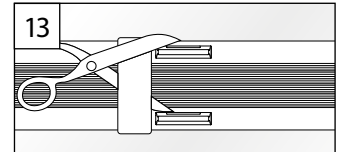
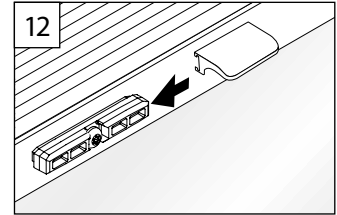
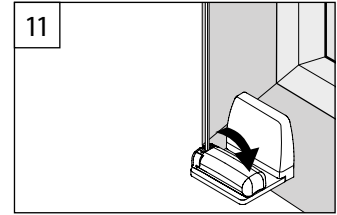
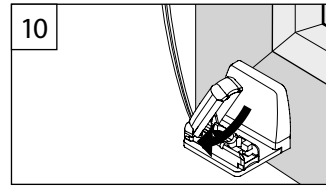
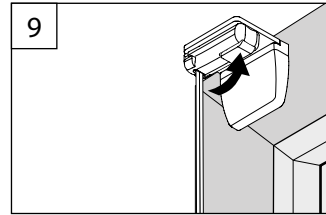
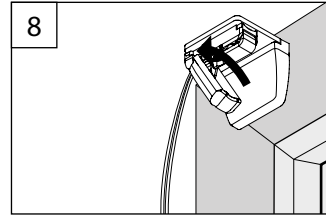
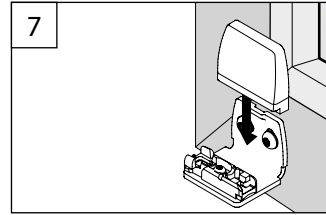

4

B Demontage

Dismantling – Démontage

SPANNSCHUH

TENSION CORD BRACKET – SUPPORT DE CÂBLES

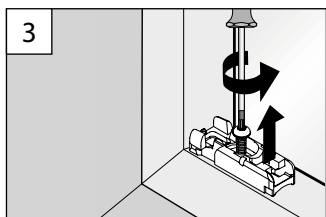
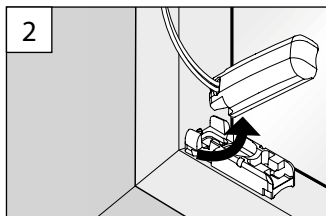
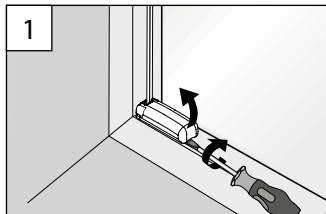

WANDWINKEL

WALL FIXING BRACKET – SUPPORT MURAL

