



Roller blinds 

Double roller blinds 

Roman blinds 

Pleated blinds 

DUETTE® 

Honeycomb pleated blinds 

Venetian blinds 

Electrical accessories

eACCU 

2024 EN



eACCU radio drive

eACCU radio motor EAM24 0.8/34 bidi

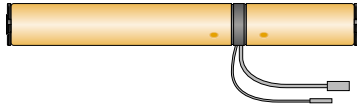

- Bidirectional radio drive with separate lithium-ion battery, either with integrated or external ACCU-pack*
- 12V DIN charge connector via the ACCU-pack
- Speed levels choosable
- Soft-stop
- Temperature range: 0 °C to 55 °C, Protection class: IP20

Integrated ACCU-pack*

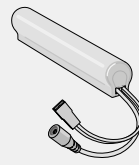

External ACCU-pack*

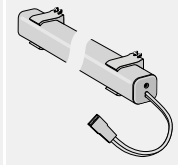

EAM24

eACCU radio motor EAM24 Top Down 2 x 0.6/34 bidi

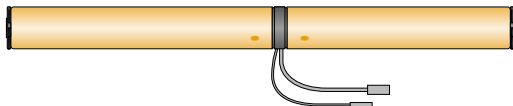
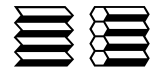

- Bidirectional radio drive with separate lithium-ion battery and external ACCU-pack*
- 12V DIN charge connector via the ACCU-pack
- Temperature range: 0 °C to 50 °C, Protection class: IP20

External ACCU-pack*

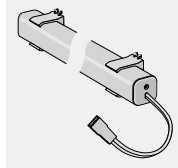

EAM24 Top Down

eACCU radio tubular motor EAM25 1.1/28 bidi



- Bidirectional radio drive with integrated lithium-ion battery
- 2200 mAh, 5 V USB-C charge connector on the motor head
- Speed levels choosable
- Soft-stop
- Status-LED on the motor head
- Temperature range: 0 °C to 55 °C, Protection class: IP20

EAM25

eACCU radio tubular motor EAM35 6/24 bidi



- Bidirectional radio drive with integrated lithium-ion battery
- 3200 mAh, 5 V USB-C charge connector 20 cm
- Speed levels choosable
- Soft-stop
- Status-LED on the motor head
- Temperature range: 0 °C to 55 °C, Protection class: IP20

EAM35

Product use / Size ranges

M-PLEATED BLINDS

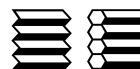

for type	Motor	integrated eACCU	external eACCU
FE	EAM24	•	•
ESM1		•	•
ESM5	EAM24 Top Down		•

SIZE RANGES

for type		integrated eACCU	external eACCU
FE / ESM1	min. width	75 cm	60 cm (70 cm)
	max. width	230 cm*	230 cm*
	max. height	260 cm*	180 cm (260 cm)*
ESM5	min. width		80 cm
	max. width		280 cm*
	max. height		260 cm*
	max. fabric weight		approx. 4.2 kg
	max. surface		approx. 5.7 m ²

Reference blind ESM1: 1250 x 1750 mm, 0.55 kg fabric weight, approx. 110 cycles ACCU (integrated) / approx. 300 cycles ACCU (external)

M-PLEATED BLINDS FOR CEILINGS



for type	Motor	integrated eACCU	external eACCU
PLE12-1, PLE12-2	EAM24		•
EWM1, EWM2			•

SIZE RANGES

for type		integrated eACCU	external eACCU
PLE12-1, PLE12-2	min. width		45 cm
EWM1, EWM2	max. width		150 cm*
	max. height		400 cm*

Reference blind PLE12-1: 1400 x 2000 mm, 0.75 kg fabric weight, slope 45°, approx. 260 cycles

VENETIAN BLINDS



for type	Motor	integrated eACCU	external eACCU
Basic Line 16	EAM24	•	•
Basic Line 25		•	•
MegaView 25		•	•

SIZE RANGES

for type		integrated eACCU	external eACCU
Basic Line 16	min. width	75 cm	65 cm
	max. width	270 cm	270 cm
	max. height	260 cm	260 cm
	max. surface	6 m ²	6 m ²
Basic Line 25 Mega View 25	min. width	75 cm	65 cm
	max. width	330 cm	330 cm
	max. height	300 cm	300 cm
	max. surface	6 m ²	6 m ²

Reference blind Basic Line 25: 1000 x 1500 mm, 1.3 kg fabric weight, approx. 100 cycles ACCU (integrated) / approx. 260 cycles ACCU (external)

*depending on the fabric and weight

Product use / Size ranges

M-ROLLER BLINDS, DOUBLE ROLLER BLINDS AND ROMAN BLINDS



for type	Motor
M-Basis	EAM25
M-roller blind with bracket profile	
M-roller blind with cassette R76, E75	
Double roller blind with bracket profile	
Double roller blind with cassette Plus	
Roman blind Makom Plus	

SIZE RANGES

for type		
M-Basis		
M-roller blind with bracket profile	min. width	60 cm (100 cm)
M-roller blind with cassette R76, E75	max. width	220 cm*
Double roller blind with bracket profile	max. height	240 cm (300 cm)*
Double roller blind with cassette Plus	max. fabric weight	approx. 2.4 kg
Roman blind Makom Plus	min. width	60 cm
	max. width	200 cm*
	max. height	250 cm*
	max. fabric weight	approx. 2 kg

Reference blind M-roller blind with bracket profile: 1300 x 1500 mm, 0.95 kg fabric weight, approx. 450 cycles

XL-ROLLER BLINDS



for type	Motor
XL-Basis	EAM35
XL-roller blind with bracket profile	
XL-roller blind with cassette E117, R120	

SIZE RANGES

for type		
XL-Basis	min. width	80 cm
XL-roller blind with bracket profile	max. width	400 cm*
XL-roller blind with cassette E117, R120	max. height	400 cm*
	max. fabric weight	approx. 8 kg

Reference blind XL-roller blind with bracket profile: 2000 x 2200 mm, 2.4 kg fabric weight, approx. 400 cycles

*depending on the fabric and weight

EAM25

EAM35



Controls

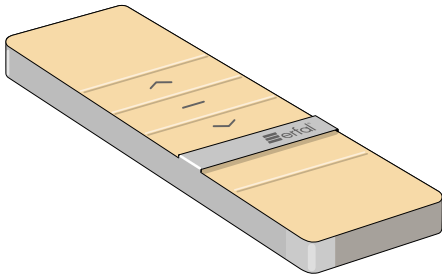

Remote control, 1-channel, for the EAM-product range

Incl. magnet board mounting brackets, Button cell CR 2450, Radio frequency: 433.92 MHz, Dimensions: 130 x 44 x 10.5 mm

Colour	Article number
white/silver	6511472

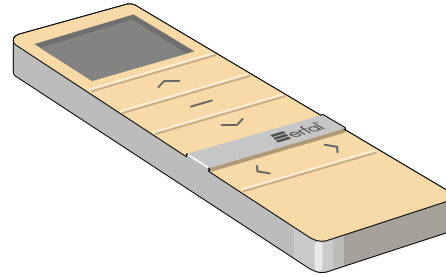

Remote control with display, 15-channel, for the EAM-product range

Incl. magnet board mounting brackets, Button cell CR 2450, Radio frequency: 433.92 MHz, Dimensions: 130 x 44 x 10.5 mm

Colour	Article number
white/silver	6511496

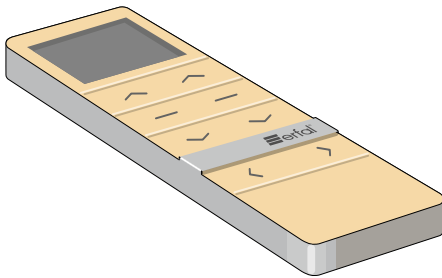

Remote control with display, 15-channel, for the EAM-product range Top Down with 2-way control

Incl. magnet board mounting brackets, Button cell CR 2450, Radio frequency: 433.92 MHz, Dimensions: 130 x 44 x 10.5 mm

Colour	Article number
white/silver	6565963

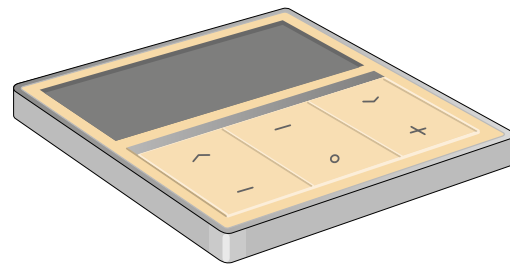

Wall-mounted transmitter with display, 15-channel, for the EAM-product range

Incl. magnet board mounting brackets, Button cell CR 2430, Radio frequency: 433.92 MHz, Dimensions: 86 x 86 x 15 mm

Colour	Article number
white/silver	6647430

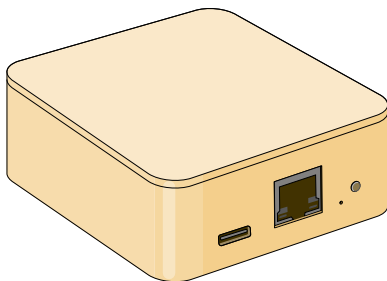

App-Box for the control of Smart Home blinds for the EAM-product range (second generation)

Incl. 100 cm USB-C cable and power supply, LAN- or WLAN-connection to the router, Internet 2,4 GHz Wi-Fi (802,11 b/g/n), Ethernet, Status LED, Radio Frequency: 433.92 MHz, Dimensions: 75 x 75 x 32 mm

Colour	Article number
white	6643517

Sensors

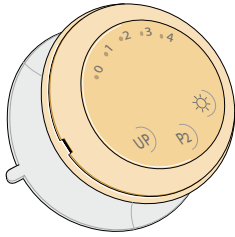

⚠ Not compatible with ESM5 Top Down pleated/ DUETTE® honeycomb pleated blinds

Radio light sensor for the EAM-product range

Incl. suction cup, Button cell CR2032, 4 different brightness thresholds, Radio frequency: 433.92, Temperature range: 0°C to 50°C, Dimension: Ø 43 mm

Colour	Article number
white	6514732

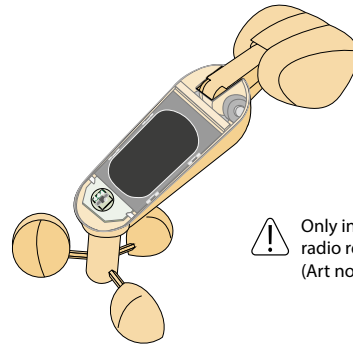

⚠ Only in connection with the radio receiver Hirschmann 230V (Art no.: 6565348)

Sensor for light and wind recognition for the EAM-product range

Power consumption: self-sufficient, Protection class: IP44, Radio frequency: 433.92 MHz, Temperature range: -10°C to 55°C, Dimensions: 240 x 150 x 20 mm

Colour	Article number
white	6576778

Wireless receivers

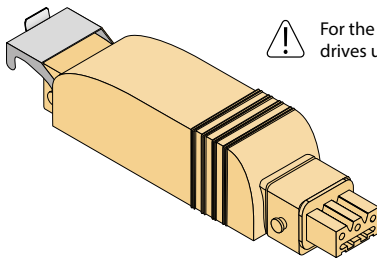

⚠ For the control of mechanical drives up to 50 Nm.

Wireless receiver Hirschmann 230 V for the EAM-product range

Wireless Slim Receiver, IP 65 protected against hose water, AC 230 V / 50 Hz, Power output 500 W, Radio frequency: 433.92 MHz, Temperature range: -10°C to 55°C, Dimensions: 152 x 32 x 30 mm

Colour	Article number
black	6565345

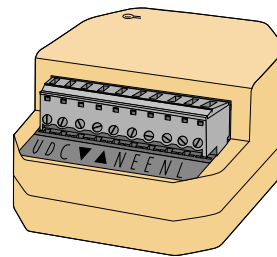

⚠ For the control of mechanical drives up to 40 Nm.

Wireless receiver (flush-mounted) for the EAM-product range

for the mounting behind existing switches, for the operation of shutters, awnings etc. AC 230 V / 50 Hz, Power output 200 W, Radio frequency: 433.92 MHz, Dimensions: 51 x 51 x 27 mm

Colour	Article number
white	6595328

Accessories for M-Pleated blinds / Venetian blinds

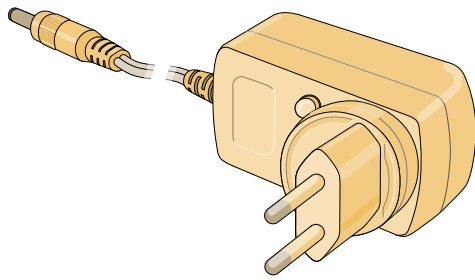

Charger (Type: DIN 12 V plug) for the EAM24

12.6 V, 1.0 A, Cable length 180 cm

Colour	Article number
white	6599227

Cable extensions for EAM24

Colour white

Type	Article number
Extension cable DIN 240 cm	6532798
Extension cable DIN 15 cm	6532996
Connection cable JST (betw. drive and ACCU pack, length: 122 cm)	6581024

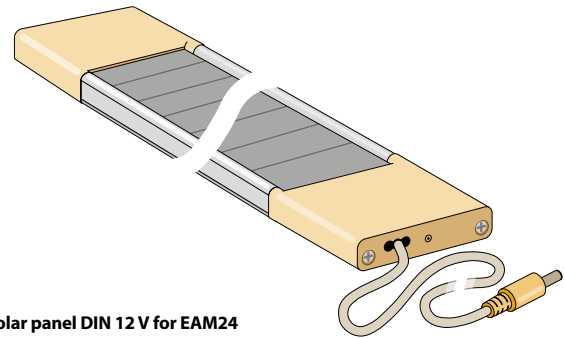

Solar panel DIN 12 V for EAM24

Adaption with the plug, cable length 200 cm, incl. fixation clip and adhesive pads, Range of application: only for the interior, Temperature range: 0°C to 50°C, Power: 3 Watt, Dimensions: 475 x 52 x 11 mm

Colour	Article number
white	6511427



An occasional reloading can be necessary due to the installing situation. The solar panel can not reload complete empty batteries! The usage on tinted panes or on triple glazing is not recommended.

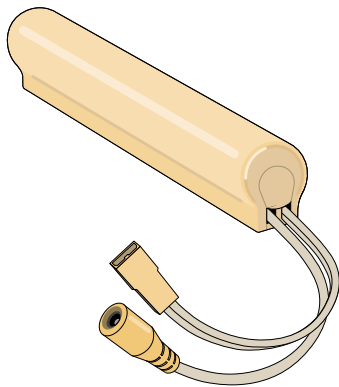

Integrated eACCU-Pack for EAM24

Colour: white

Type	Article number	Capacity	Voltage	Measures	Charging connection	Charging time
Integrated	6617211	900 mAh	12 V	110 x 22 x 18 mm	DIN socket, cable 185 mm	approx. 2 h

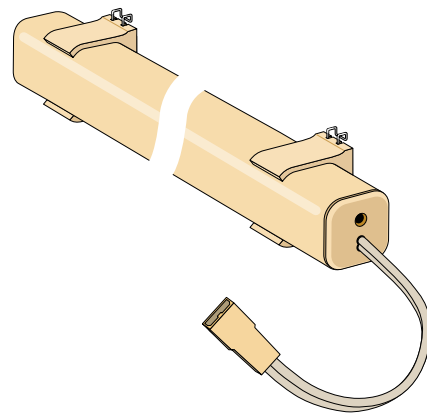

External eACCU-Pack for EAM24

Colour: white, incl. clamping fixation for screwing / mounting

Type	Article number	Capacity	Voltage	Measures	Charging connection	Charging time
External	6527749	2550 mAh	12 V	247 x 27 x 27 mm	DIN socket, on the face	approx. 6 h



Pleated blind EWM1, EWM2, ESM5, PLE12-1 and PLE12-2 are only possible with an external eACCU pack.

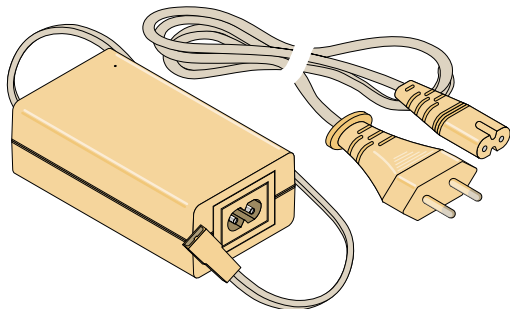

Group power supply for radio motor EAM 24

for a maximum of 5 blinds, 12 V - 5 A, 230 V, cable length: 150 cm, Measures: 150 x 85 x 45 mm

Colour	Article number
white	6626787

Accessories for Roller blinds / Double roller blinds / Roman blinds / L-Plated blinds

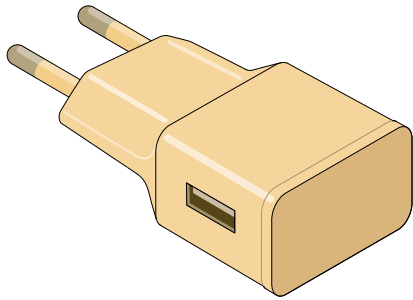

USB power supply 5 V plug EU for EAM25 / EAM35

5.0 V - 2.0 A, 100-240 V AC, charging adapter with USB-A connection

Colour	Article number
white	6617204

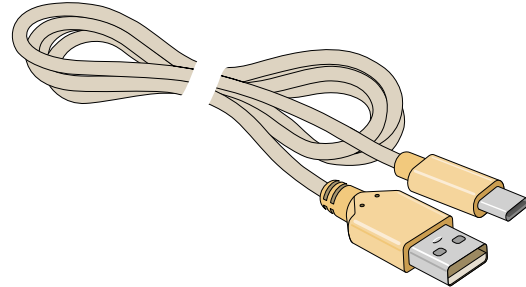

USB charging cable 300 cm for EAM25 / EAM35

Plug USB-A to USB-C

Colour	Article number
white	6617235

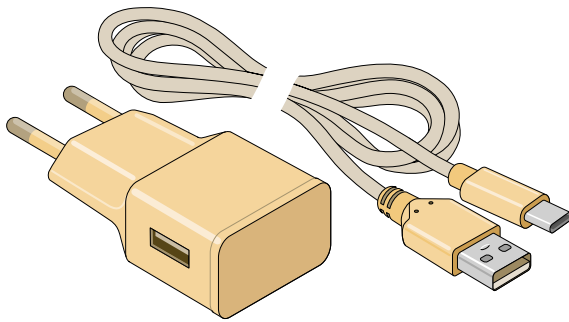

Set USB power supply (incl. charging cable 300 cm) for EAM25 / EAM35

5.0 V - 2.0 A, 100-240 V AC, charging adapter with USB-A connection incl. charging cable for the switch from USB-A to USB-C

Colour	Article number
white	6617952

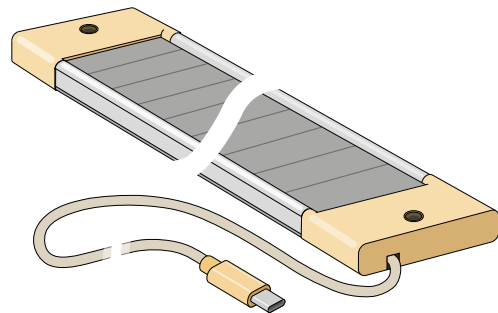

Solarpanel USB-C 5 V für EAM25 / EAM35

(including brackets and screws), adaption via USB-C plug, cable length 190 cm, for the interior and exterior, Temperature range: -10°C to 55°C, Protection class: IP55, Power: 4.7 Watt, Dimensions: 550 x 65 x 10 mm

Colour	Article number
black	6617549



An occasional reloading can be necessary due to the installing situation. The solar panel can not reload complete empty batteries! The usage on tinted panes or on triple glazing is not recommended.





App-Information

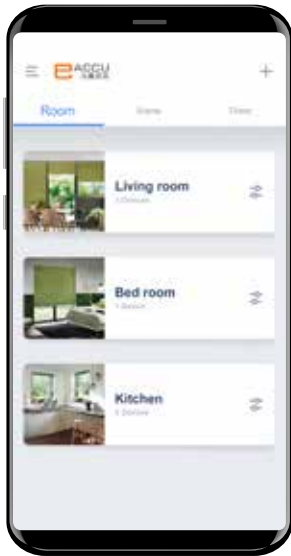

Smart controls - suitable for all eACCU radio drives of the EAM-product range

- Free application for Android & iOS
- Easy connection via WLAN
- Can be operated from everywhere by smartphone & tablet
- Easy and smart control through voice commands
- Compatible with Amazon Alexa, Google Assistant, Apple Siri and IFTTT
- Timer and Astro function
- Individual scenes
- Modern and timeless design

Downloads and further information



You can find further information on the erfal website:

www.erfal.de/en/products/smarthome/electric-battery-operated-drive

Programming videos

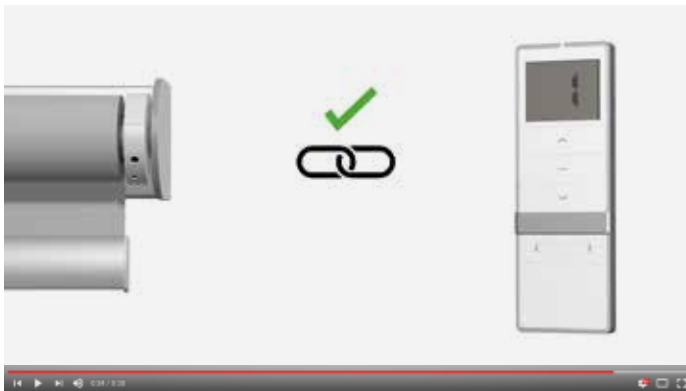

You can find all programming videos of the EAM-product range in the playlist eACCU of the erfal YouTube-channel <http://bit.ly/eACCU-Bedienungsanleitungen> or comfortable through the scan of the opposite QR-code.

YouTube



Indications

- eACCU radio drives must be protected against impacts during transport, storage and mounting. Damaged components must be replaced.
- Only use these products indoors.
- Charge the eACCU fully for about 6 hours before use, as it is only partially charged in the delivery state.
- The LED on the charger changes from red to green as soon as the charging process is complete. The LED on the motor head will flash during the charging process and will shine permanently green when the rechargeable battery is fully charged.
- Test results of the reference systems in the long-term test (180 s / cycle) can be found in the section „Product use / size ranges“. One cycle corresponds an up and down drive. The durability depends on the size of the system, the fabric weight, self-consumption and external influences, such as radio environment and temperatures.
- The programming of the channels and the end positions are permanently saved and are retained even when the eACCU is completely discharged.
- The radio range is up to approx. 20 m through two concrete walls and up to 200 m on free spaces.
- For eACCU radio drives, a minimum distance of 20 cm between each other must be observed to avoid interference.

MAKE YOUR CONTRIBUTION TO AN ECO-FRIENDLY RECYCLING.



After use, disconnect the system, motor and (rechargeable) batteries and dispose of the parts separately. Due to the obligations arising from the WEEE directive of the EU, erfal, as a manufacturer or distributor of electrical and electronic devices, takes back controls, drives, other electrical accessories, old batteries and accumulators for free of charge. Please contact your seller for the exact processing. End users are legally obliged to delete personal data on old devices before disposal. The delivery should always take place in a discharged state and protected against short circuits.

® DUETTE® is a registered trademark of Hunter Douglas.

Roller blinds / Double roller blinds / Roman blinds / Pleated blinds / DUETTE® Honeycomb pleated blinds / Venetian blinds - Electrical accessories eACCU

All indicated prices (in Euro) are net purchasing prices or rather non-binding recommended brut selling prices (incl. VAT).

Changes, which serve for technical improvements, are reserved. The existing catalogue is protected by copyright.

Slight colour differences are possible and are not entitling for claims. Reproduction, including excerpts, is subject to the previous permission by erfal GmbH & Co. KG. Printing and typesetting errors are excepted. Edition of April 2024

erfal GmbH & Co. KG
www.erfal.com