

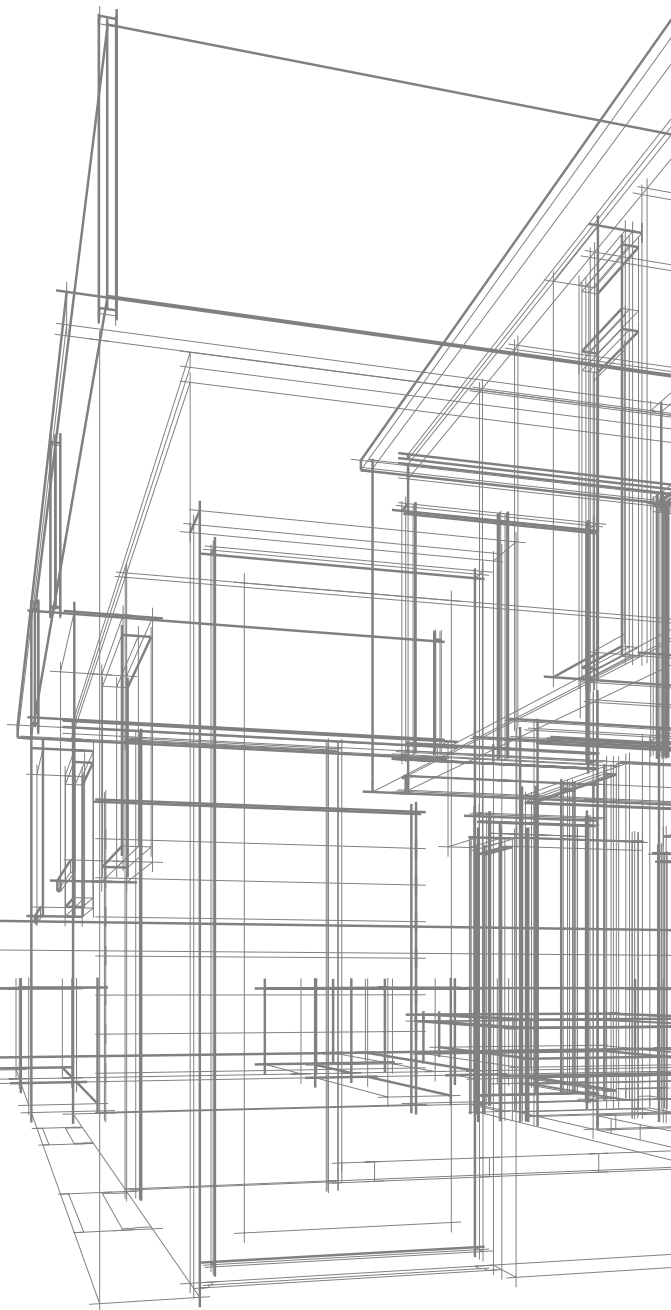

ALUSCHIENEN

Übersicht	01
Schleuderschienen	04
Objektschienen	10
Einbauschiene	16
Raumtrennschiene	18
Schnurzugschienen	22
Motorschienen	28
Bilderschienen	37
Zubehör	40



Schleuderschienen

SYSTEM 3600

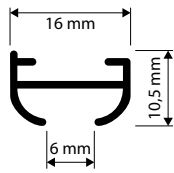

SYSTEM 3700

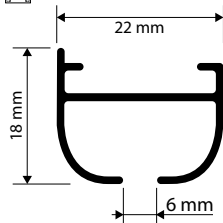

SYSTEM 4700

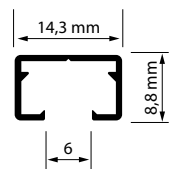

SYSTEM 4710

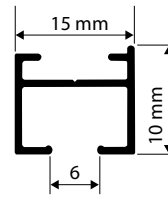

SYSTEM 5000

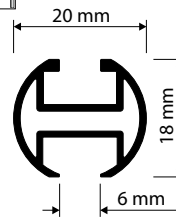

SYSTEM 5100

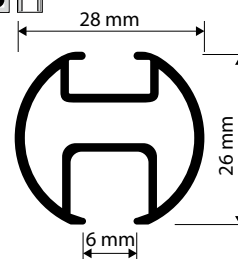

Objektschienen

SYSTEM 4300

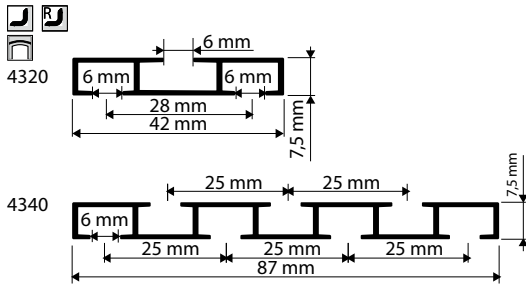

SYSTEM 4500

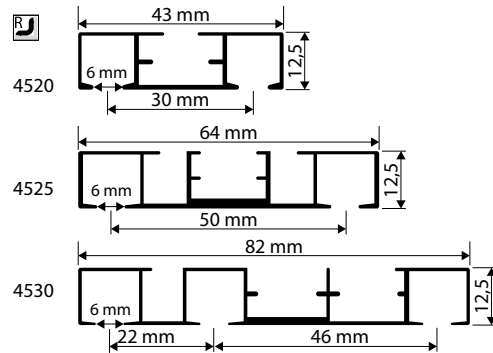

SYSTEM 4400

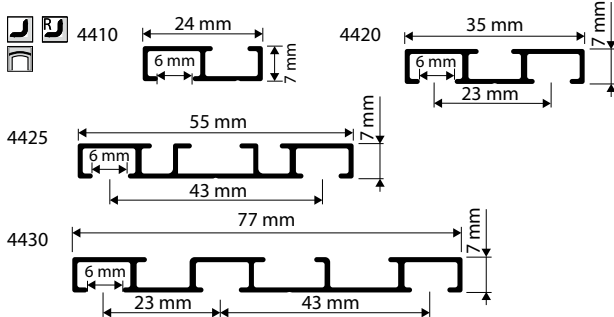

Einbauschienen

SYSTEM 4600

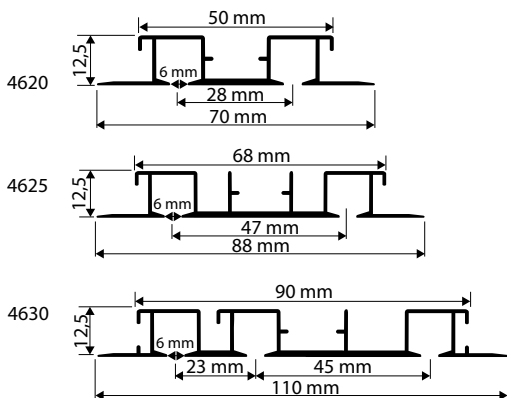

SYSTEM 4850

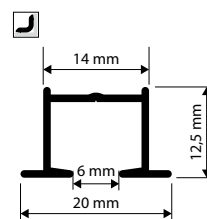

Raumtrennschienen

SYSTEM 4100

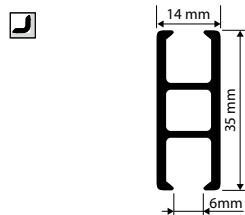

SYSTEM 5100

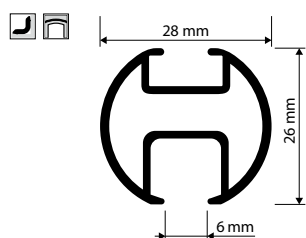

Schnurzugschienen

SYSTEM 5200

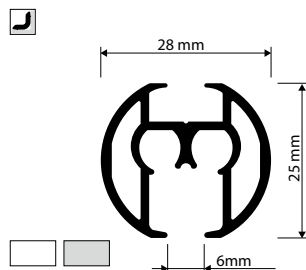

SYSTEM 5500

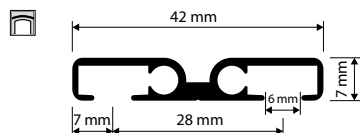

SYSTEM 8100

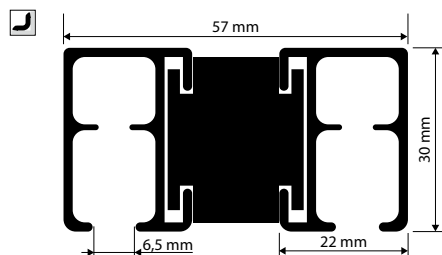

Motorschienen

SYSTEM 9500

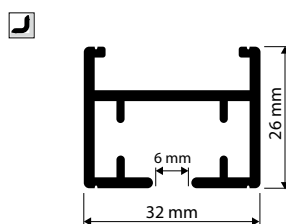

SYSTEM 9550

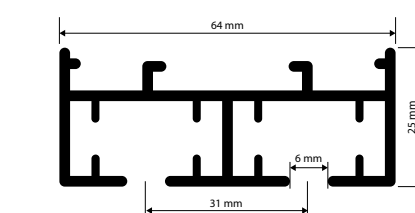

Bilderschienen

SYSTEM 2200

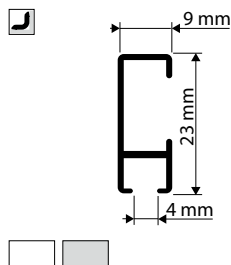

Farben

	weiß		horizontale Biegung
	silber		vertikale Biegung
	bronze		Retourenbiegung
	messing matt		
	edelstahlfarben		

RAL-Farben auf Anfrage (siehe coflex Farbprogramm)

System 3600

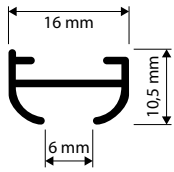

PRODUKTMERKMALE

- flache Schiene mit abgerundetem Design
- geringer Platzbedarf und verdeckte Montage
- Deckenmontage
- Spurbreite 6 mm
- Lagerlänge 6 m

LIEFERBARE FARBEN

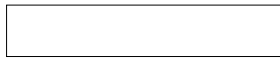

weiß (RAL 9016)



silber (eloxiert)



messing matt (eloxiert)



bronze (eloxiert)

BELASTUNGSTABELLE



STANDARDKOMPONENTEN

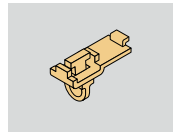
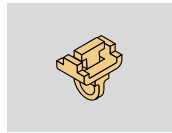
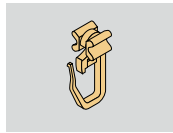

wird nur bei Ausklinkung geliefert

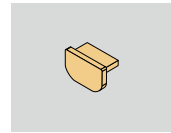
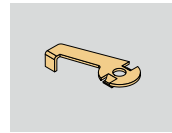

GLEITER WÄHLBAR (ohne Aufpreis)

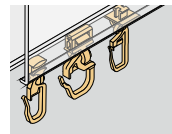
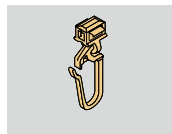

Genauere Bezeichnung von Standardkomponenten und Gleitern, sowie weitere Gleiter finden Sie unter **Zubehör** (evtl. Mehrpreis beachten!).

MONTAGEMÖGLICHKEITEN

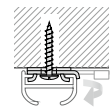

Schiene ist kompatibel mit folgendem Wellenband



BIEGUNG



horizontale Biegung

mögliche Radien: **10 cm, ab 40 cm jeder Radius**



vertikale Biegung

mögliche Radien: **5 cm, ab 40 cm jeder Radius**

System 3700

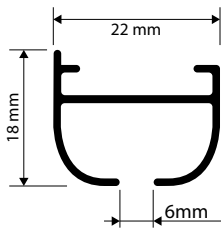

PRODUKTMERKMALE

- stabile Schiene mit abgerundetem Design
- verdeckte Montage
- Deckenmontage
- Verwendung von Rollen möglich
- Spurbreite 6 mm
- Lagerlänge 6 m

LIEFERBARE FARBEN



weiß (RAL 9016)



silber (eloxiert)

BELASTUNGSTABELLE

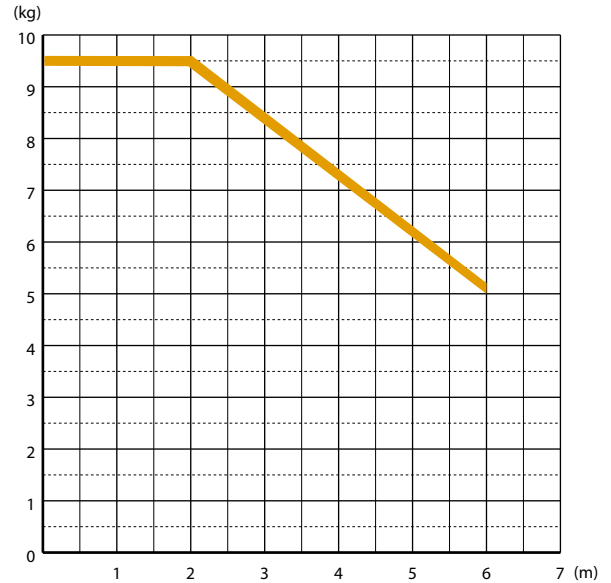

Bitte verwenden Sie bei schweren Vorhängen **Rollen bzw. Objektgleiter**.

STANDARDBAKOMPONENTEN

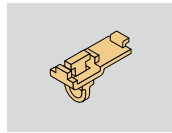
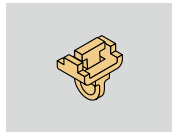

wird nur bei Ausklükung geliefert

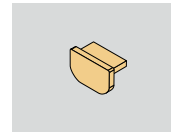
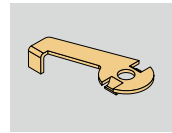

GLEITER WÄHLBAR (ohne Aufpreis)

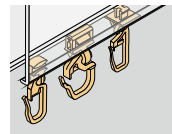
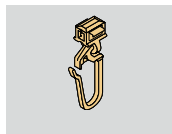
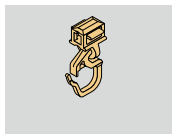

Genauere Bezeichnung von Standardkomponenten und Gleitern, sowie weitere Gleiter finden Sie unter **Zubehör** (evtl. Mehrpreis beachten!).

MONTAGEMÖGLICHKEITEN

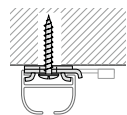

BIEGUNG



horizontale Biegung

mögliche Radien: **15 cm, ab 40 cm jeder Radius**

Schiene ist kompatibel mit folgendem Wellenband

NEUAVE

LaOla.



vertikale Biegung

mögliche Radien: **15 cm, ab 40 cm jeder Radius**

System 4700

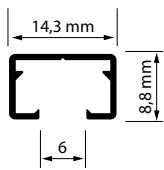

PRODUKTMERKMALE

- geradliniges Profil aus stranggepresstem Aluminium
- Deckenmontage
- Spurbreite 6 mm
- Lagerlänge 6 m
- Schiene vorgebohrt (ca. alle 25 cm / Ø 3 mm)

LIEFERBARE FARBEN



weiß (RAL 9016)

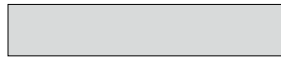

silber (eloxiert)

BELASTUNGSTABELLE

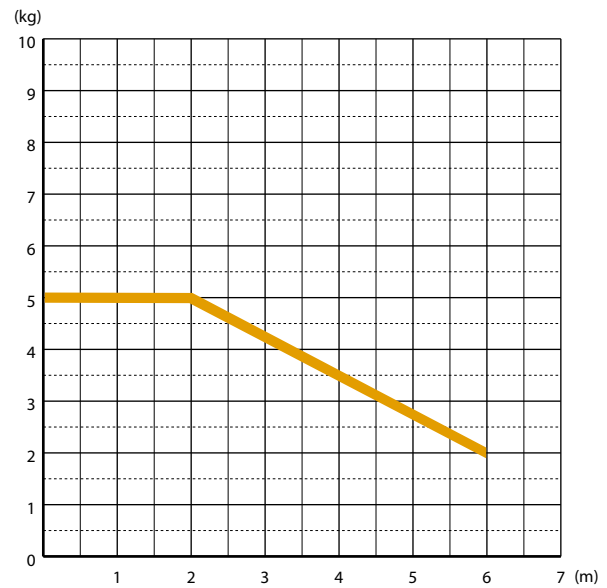

STANDARDKOMPONENTEN

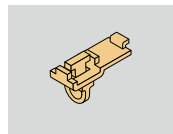
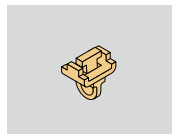

wird nur bei Ausklinkung geliefert

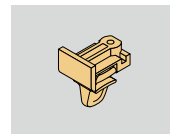
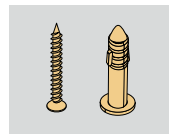

GLEITER WÄHLBAR (ohne Aufpreis)

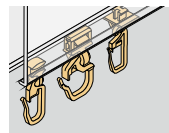
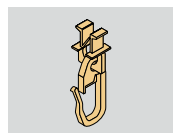
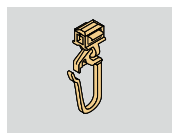

Genauere Bezeichnung von Standardkomponenten und Gleitern, sowie weitere Gleiter finden Sie unter **Zubehör** (evtl. Mehrpreis beachten!).

MONTAGEMÖGLICHKEITEN

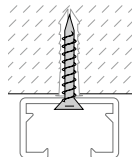
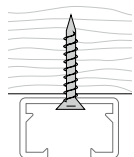

Schiene ist kompatibel mit folgendem Wellenband



BIEGUNG



horizontale Biegung

mögliche Radien: **10 cm, ab 40 cm jeder Radius**

weitere Infos siehe Aluschiene-Systeme Kapitel **Biegung**

System 4710

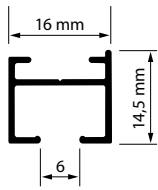

PRODUKTMERKMALE

- moderne eckig gehaltene Schiene
- geringer Platzbedarf und verdeckte Montage
- Deckenmontage
- Spurbreite 6 mm
- Lagerlänge 6 m

LIEFERBARE FARBEN

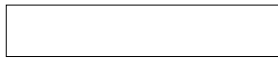

weiß (RAL 9016)



silber (eloxiert)



schwarz (RAL 9017/matt)



edelstahlfarben (eloxiert/gebürstet)

BELASTUNGSTABELLE

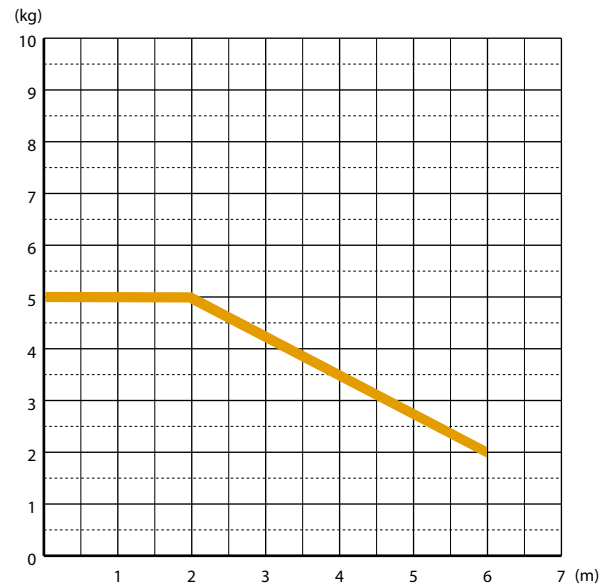

STANDARDKOMPONENTEN

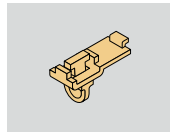
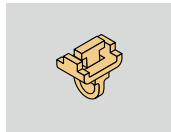

wird nur bei Ausklüftung geliefert



weiß, grau, schwarz oder edelstahlfarben

GLEITER WÄHLBAR (ohne Aufpreis)

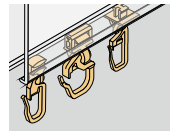
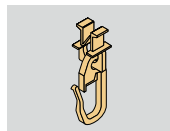
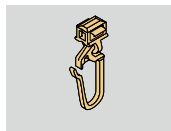

Genauere Bezeichnung von Standardkomponenten und Gleitern, sowie weitere Gleiter finden Sie unter **Zubehör** (evtl. Mehrpreis beachten!).

MONTAGEMÖGLICHKEITEN

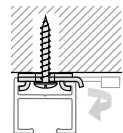

Schiene ist kompatibel mit folgendem Wellenband

NEUAVE

LaOla.

BIEGUNG



horizontale Biegung

mögliche Radien: **10 cm, ab 40 cm jeder Radius**

weitere Infos siehe Aluschienen-Systeme Kapitel **Biegung**

System 5000

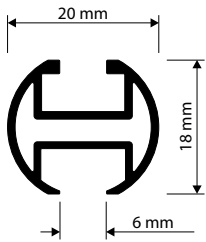

PRODUKTMERKMALE

- rundes Aluminiumprofil
- vielseitig einsetzbar
- für Decken- und Wandmontage
- Laufkanal 6 mm
- Spurbreite 6 mm
- Lagerlänge 6 m

LIEFERBARE FARBEN

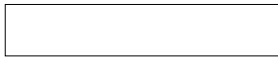

weiß (RAL 9016)



silber (eloxiert)



messing matt (eloxiert)



edelstahlfarben (eloxiert)

BELASTUNGSTABELLE

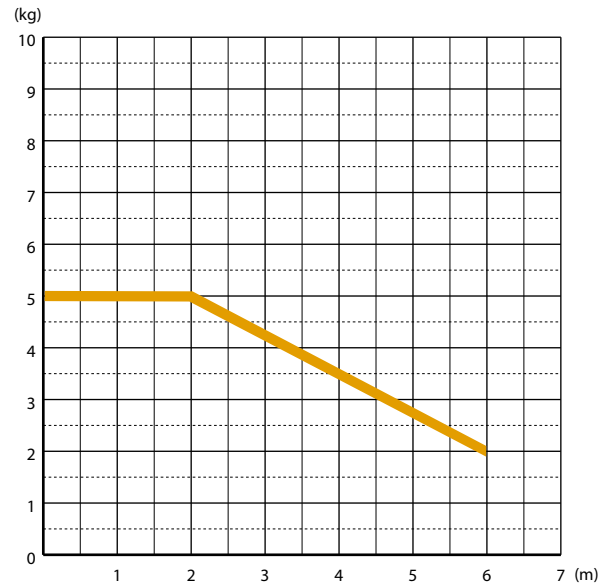

STANDARDKOMPONENTEN

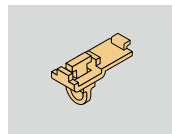
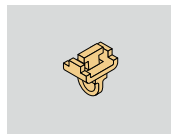

wird nur bei Ausklinkung geliefert

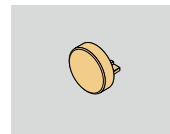

GLEITER WÄHLBAR (ohne Aufpreis)

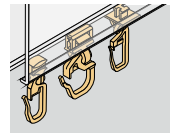
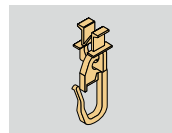
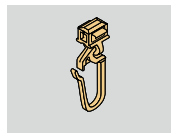

Genauere Bezeichnung von Standardkomponenten und Gleitern, sowie weitere Gleiter finden Sie unter **Zubehör** (evtl. Mehrpreis beachten!).

MONTAGEMÖGLICHKEITEN

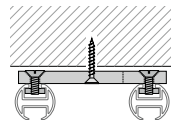
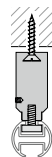
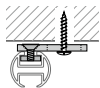

Schiene ist kompatibel mit folgendem Wellenband



BIEGUNG



horizontale Biegung

mögliche Radien: **15 cm, ab 40 cm jeder Radius**



vertikale Biegung

mögliche Radien: **15 cm, ab 40 cm jeder Radius**

weitere Infos siehe Aluschiene-Systeme Kapitel **Biegung**

System 5100

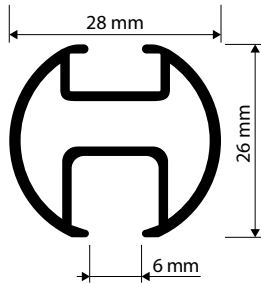

PRODUKTMERKMALE

- universell einsetzbares und stabiles Raumtrennprofil
- Einsatzbereich in Krankenhäusern, Arztpraxen, Physiotherapien, Werkstätten, Umkleidekabinen
- Decken-, Wand- und Abhängemontage
- Verwendung von Rollen möglich
- Spurbreite 6 mm
- Lagerlänge 7 m

LIEFERBARE FARBEN



weiß (RAL 9016)



silber (eloxiert)

BELASTUNGSTABELLE



Bitte verwenden Sie bei schweren Vorhängen **Rollen** bzw. **Objektgleiter**.

STANDARDKOMPONENTEN

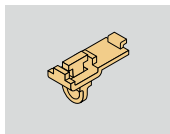
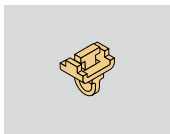
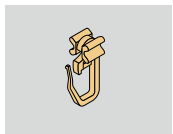

wird nur bei Ausklüpfung geliefert

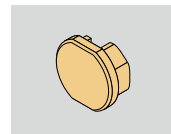

GLEITER WÄHLBAR (ohne Aufpreis)

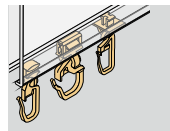

Genauere Bezeichnung von Standardkomponenten und Gleitern, sowie weitere Gleiter finden Sie unter **Zubehör** (evtl. Mehrpreis beachten!).

MONTAGEMÖGLICHKEITEN

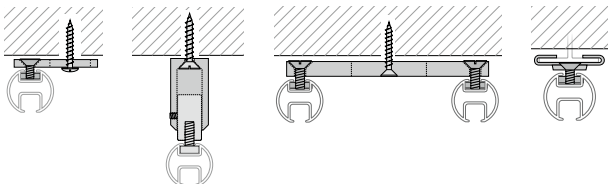

Schiene ist kompatibel mit folgendem Wellenband

NEUAVE

LaOla.

BIEGUNG



horizontale Biegung

mögliche Radien: **15 cm, ab 40 cm jeder Radius**



vertikale Biegung

mögliche Radien: **15 cm, ab 40 cm jeder Radius**

System 4300

SCHIENE 4320

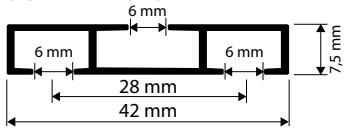

SCHIENE 4340

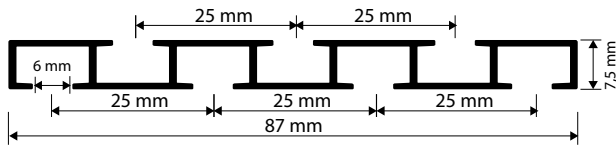

PRODUKTMERKMALE

- sehr flaches Aluminiumprofil
- Schiene als 1- oder 2- bzw. 3- oder 4-Lauf verwendbar
- Deckenmontage
- Spurbreite 6 mm
- Lagerlänge 6 m

LIEFERBARE FARBEN



weiß (RAL 9016)



silber (RAL 9006)

BELASTUNGSTABELLE

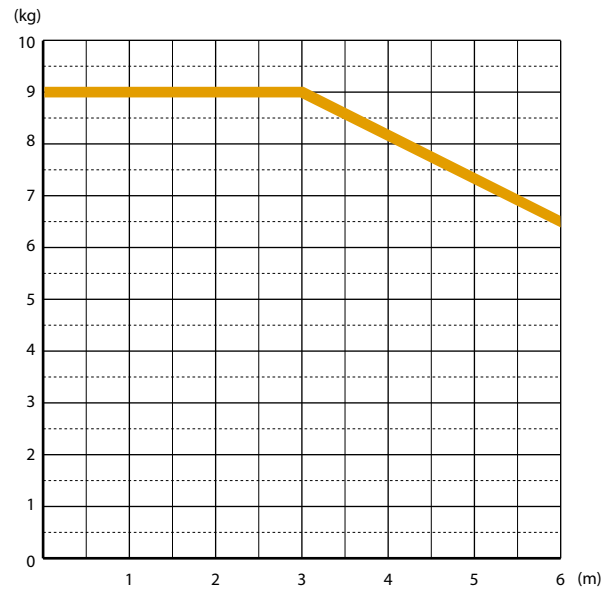

Bitte verwenden Sie bei schweren Vorhängen **Objektgleiter**.

Schiene ist kompatibel mit folgendem Wellenband



STANDARDKOMPONENTEN

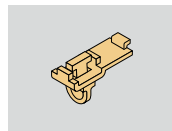
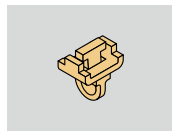

wird nur bei Ausklinkung geliefert

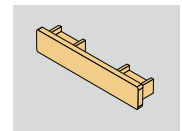
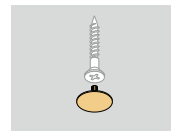
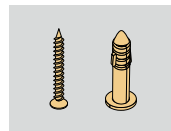

GLEITER WÄHLBAR (ohne Aufpreis)

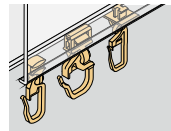
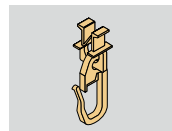

Genauere Bezeichnung von Standardkomponenten und Gleitern, sowie weitere Gleiter finden Sie unter **Zubehör** (evtl. Mehrpreis beachten!).

MONTAGEMÖGLICHKEITEN

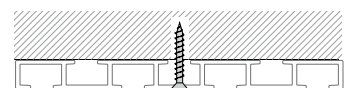
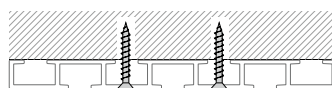
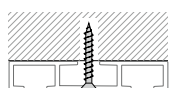

RETOURENBIEGUNG



Retourbiegung für 4320

mögliche Radien: **20 cm**

BIEGUNG



horizontale Biegung für 4320

mögliche Radien: **20 cm, ab 40 cm jeder Radius**



vertikale Biegung für 4320

mögliche Radien: **20 cm, ab 40 cm jeder Radius**

RETOURENBIEGUNG

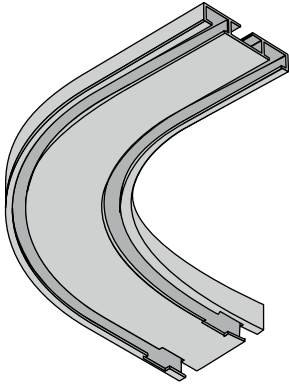

Modell 4320

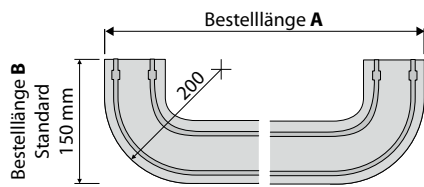

GEHRUNGSSCHNITT

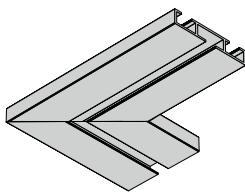

Modell 4320 – 1-Lauf

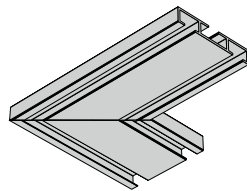

Modell 4320 – 2-Lauf

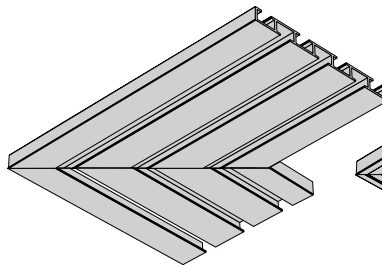

Modell 4340 – 3-Lauf

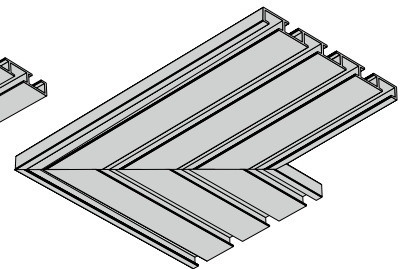

Modell 4340 – 4-Lauf

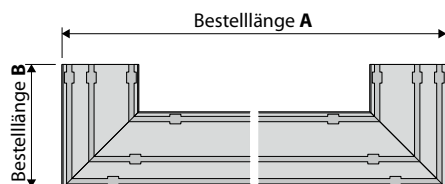

Gehrungsschnitt 4320 inkl. 1 Eckverbinder
Gehrungsschnitt 4340 inkl. 2 Eckverbinder

System 4400

SCHIENE 4410

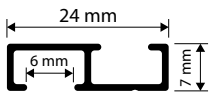

SCHIENE 4420

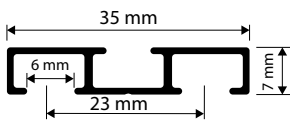

SCHIENE 4425

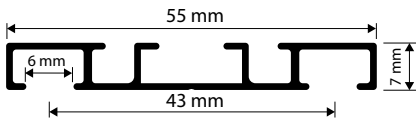

SCHIENE 4430

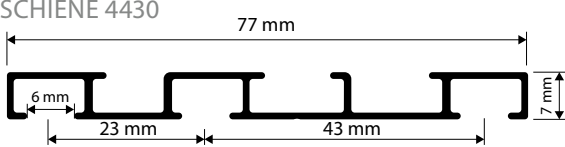

BELASTUNGSTABELLE

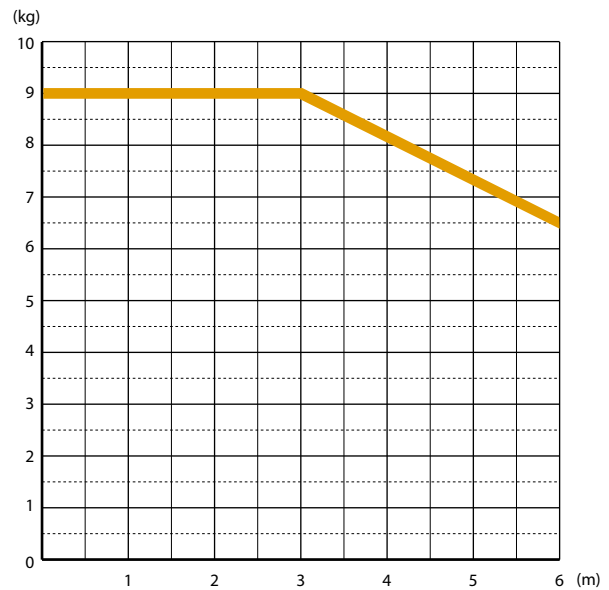

Bitte verwenden Sie bei schweren Vorhängen **Objektgleiter**.

PRODUKTMERKMALE

- sehr flaches Aluminiumprofil
- verschiedene Laufvarianten in gleicher Optik
- objektgeeignet
- für Deckenmontage
- Spurbreite 6 mm
- Lagerlänge 6 m

LIEFERBARE FARBEN



weiß (RAL 9016)



silber (eloxiert)

Schiene ist kompatibel mit folgendem Wellenband



STANDARDKOMPONENTEN

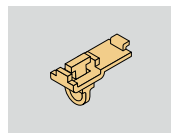
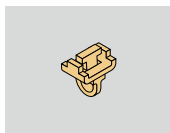
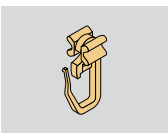

wird nur bei Ausklinkung geliefert

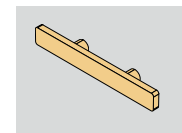
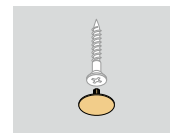
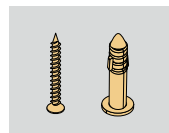

GLEITER WÄHLBAR (ohne Aufpreis)

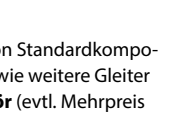
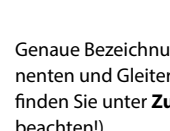
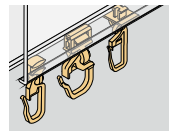
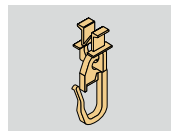

Genauere Bezeichnung von Standardkomponenten und Gleitern, sowie weitere Gleiter finden Sie unter **Zubehör** (evtl. Mehrpreis beachten!).

MONTAGEMÖGLICHKEITEN

SCHRAUBMONTAGE

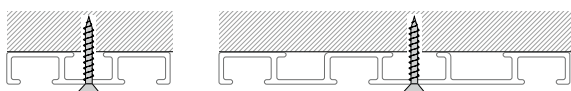
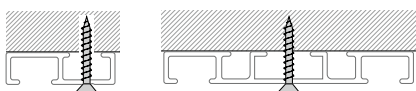

DECKENSPANNER



RETOURENBIEGUNG



mögliche Radien: **10 cm, 15 cm** (bitte Biegeausführung beachten)

BIEGUNG



mögliche Radien: **10 cm, 15 cm, ab 40 cm** jeder Radius (bitte Biegeausführung beachten)

horizontale Biegung



vertikale Biegung

für 4410 und 4420
mögliche Radien:
20 cm, ab 40 cm jeder Radius

RETOURENBIEGUNG

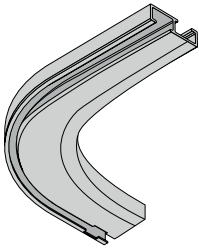

Modell 4410

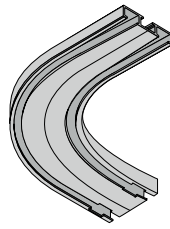

Modell 4420

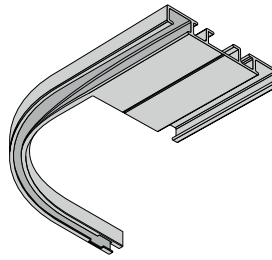

Modell 4425

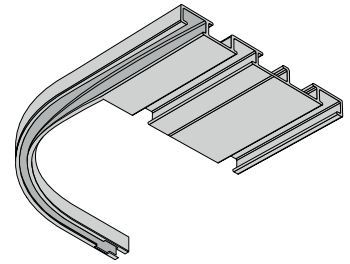

Modell 4430

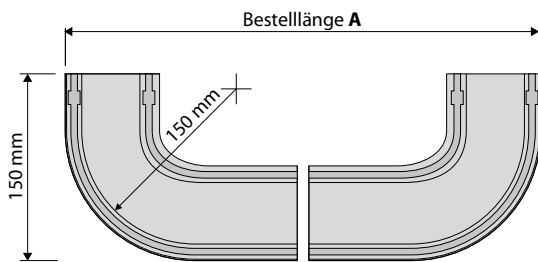

Retourenbiegung 4410/4420

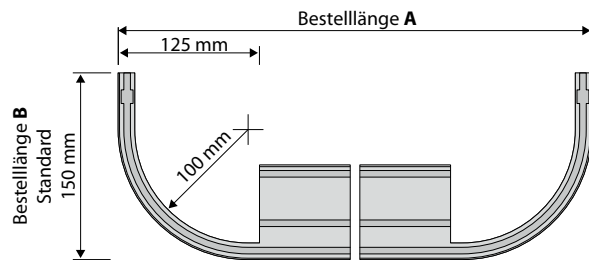

Retourenbiegung 4425/4430

GEHRUNGSSCHNITT

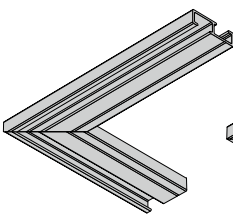

Modell 4410

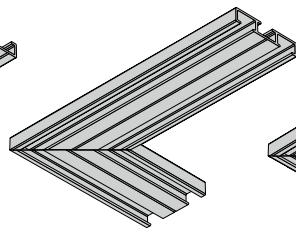

Modell 4420

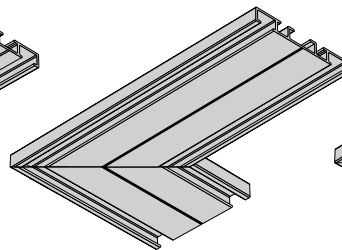

Modell 4425

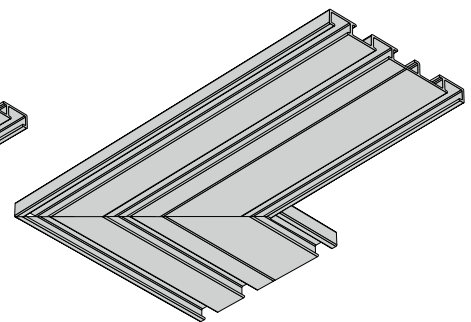

Modell 4430

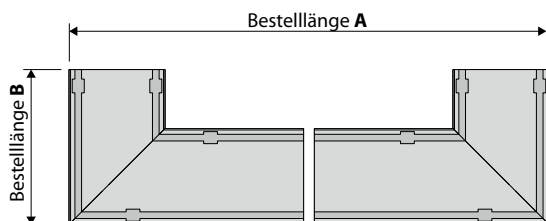

Gehrungsschnitt inkl. 1 Eckverbinder

System 4500

SCHIENE 4520

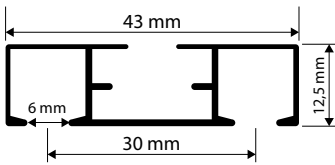

SCHIENE 4525

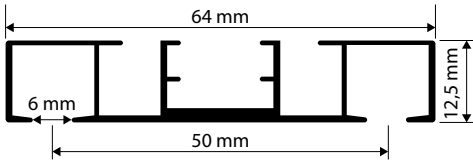

SCHIENE 4530

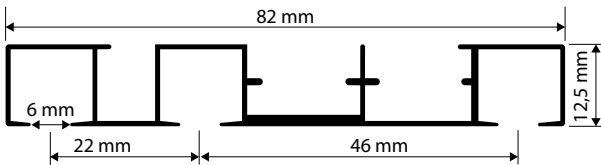

PRODUKTMERKMALE

- flache Deckenschiene aus Aluminium
- objektgeeignet
- Deckenmontage
- Spurbreite 6 mm
- Lagerlänge 6 m

LIEFERBARE FARBEN



weiß (RAL 9016)



silber (eloxiert)

STANDARDKOMPONENTEN

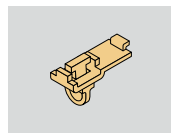
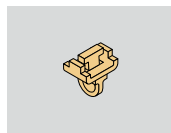

wird nur bei Ausklinkung geliefert

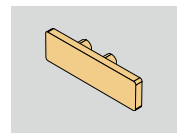
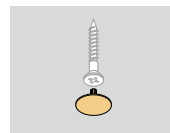
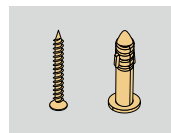

GLEITER WÄHLBAR (ohne Aufpreis)

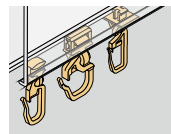
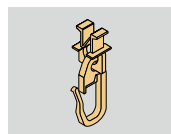
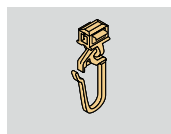

Genauere Bezeichnung von Standardkomponenten und Gleitern, sowie weitere Gleiter finden Sie unter **Zubehör** (evtl. Mehrpreis beachten!).

MONTAGEMÖGLICHKEITEN

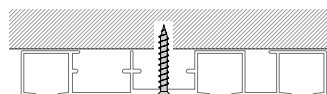
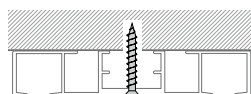
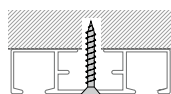

RETOURENBIEGUNG



mögliche Radien: **10 cm**
(bitte Biegeausführung beachten)

BELASTUNGSTABELLE

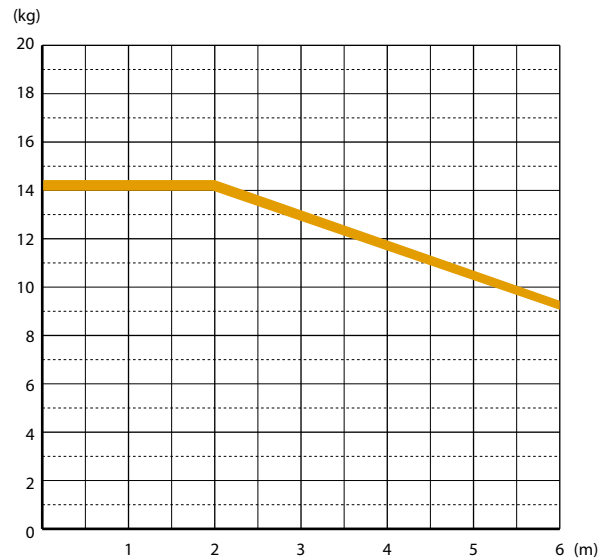

Bitte verwenden Sie bei schweren Vorhängen **Rollen bzw. Objektgleiter**.

Schiene ist kompatibel mit folgendem Wellenband

NEUAVE

LaOla.

RETOURENBIEGUNG

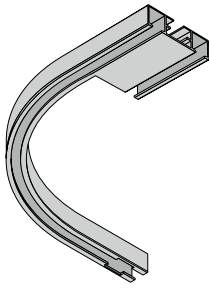

Modell 4520

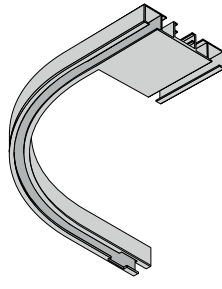

Modell 4525

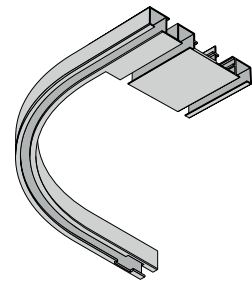

Modell 4530

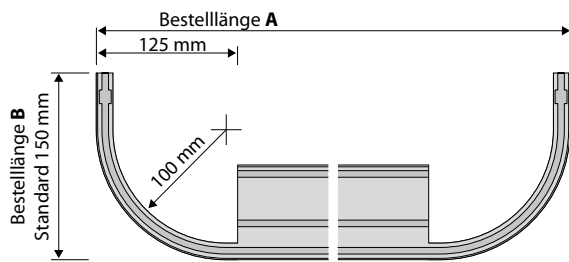

GEHRUNGSSCHNITT

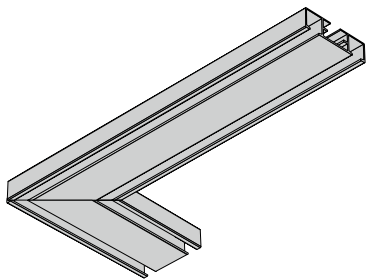

Modell 4520

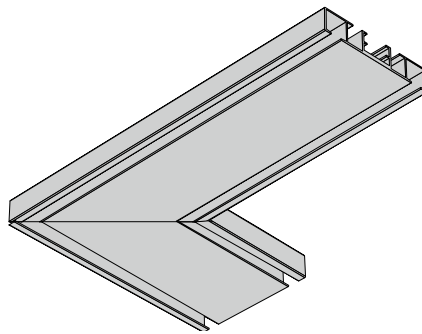

Modell 4525

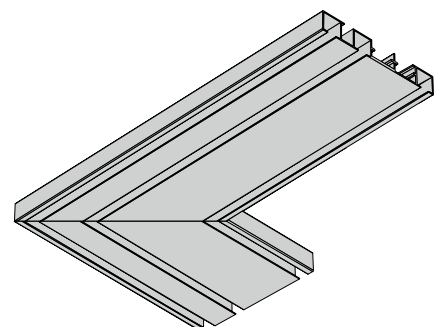

Modell 4530

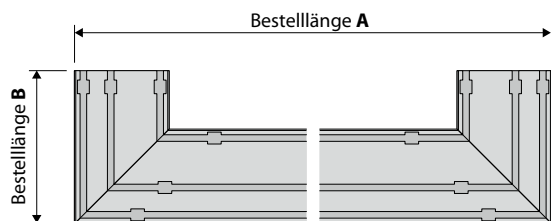

System 4600

SCHIENE 4620

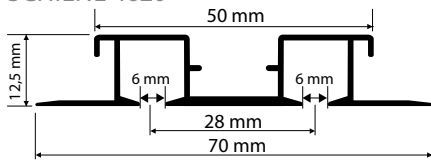

SCHIENE 4625

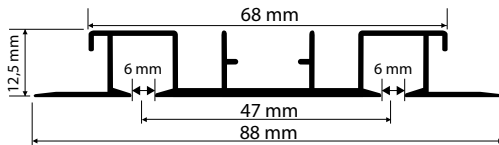

SCHIENE 4630

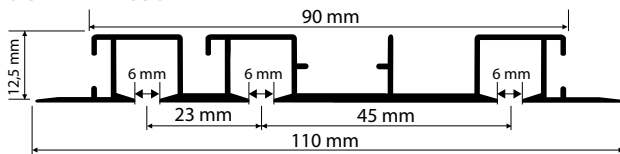

PRODUKTMERKMALE

- objektgeeignetes Einbauprofil aus Aluminium
- Einbau in abgehängten Decken
- Spurbreite 6 mm
- Lagerlänge 6 m

LIEFERBARE FARBEN

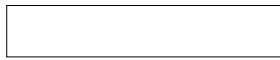

weiß (RAL 9016)

STANDARDKOMPONENTEN

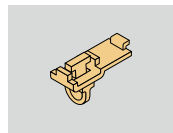
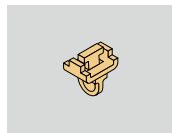

wird nur bei Ausklinkung geliefert

GLEITER WÄHLBAR (ohne Aufpreis)

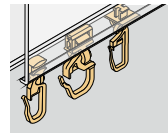
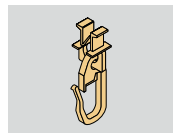

Genauere Bezeichnung von Standardkomponenten und Gleitern, sowie weitere Gleiter finden Sie unter **Zubehör** (evtl. Mehrpreis beachten!).

MONTAGEMÖGLICHKEITEN

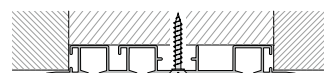
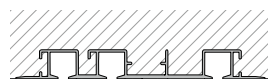
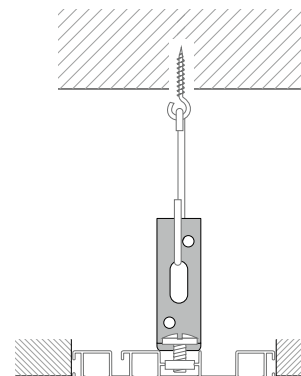

BELASTUNGSTABELLE

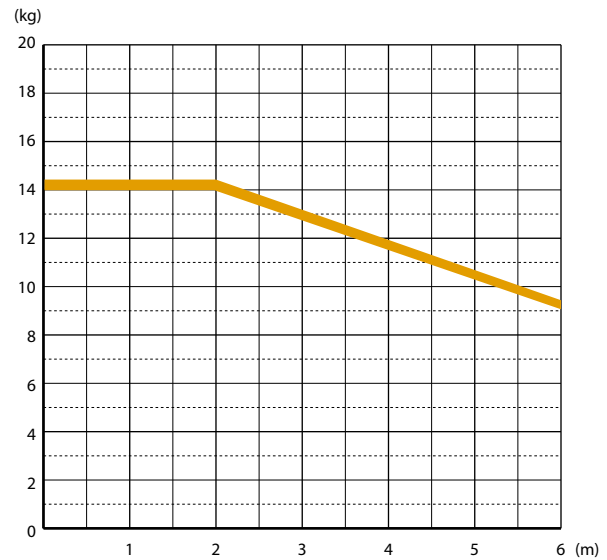

Bitte verwenden Sie bei schweren Vorhängen **Rollen bzw. Objektgleiter**.

Schiene ist kompatibel mit folgendem Wellenband

NEUAVE

LaOla.

System 4850

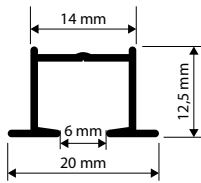

PRODUKTMERKMALE

- elegantes Nutprofil für Holzunterkonstruktion sowie Gipskarton mit mind. 12 mm Stärke
- Deckenmontage
- Verwendung von Rollen möglich
- Spurbreite 6 mm
- Lagerlänge 6 m
- vorgebohrt alle 15 cm

LIEFERBARE FARBEN



weiß (RAL 9016)



silber (eloxiert)

BELASTUNGSTABELLE

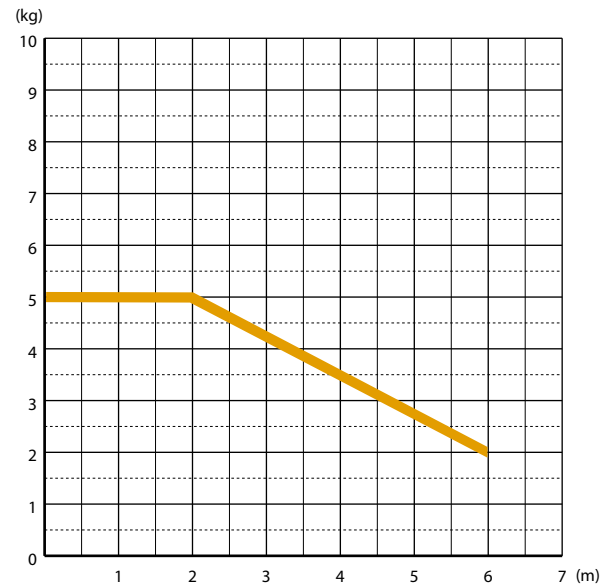

Schiene ist kompatibel mit folgendem Wellenband

NEUAVE

LaOla.

STANDARDKOMPONENTEN

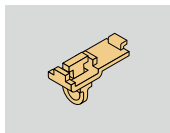
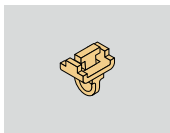

wird nur bei Ausklinkung geliefert



GLEITER WÄHLBAR (ohne Aufpreis)

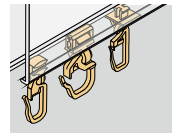

Genauere Bezeichnung von Standardkomponenten und Gleitern, sowie weitere Gleiter finden Sie unter **Zubehör** (evtl. Mehrpreis beachten!).

MONTAGEMÖGLICHKEITEN

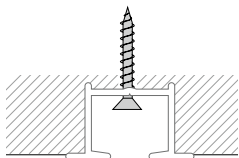

BIEGUNG



horizontale Biegung

mögliche Radien: **ab 40 cm jeder Radius**

System 4100

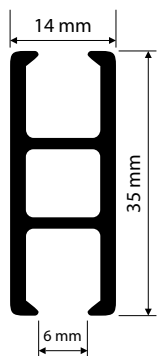

PRODUKTMERKMALE

- universell einsetzbares und stabiles Raumtrennprofil
- Einsatzbereich in Krankenhäusern, Arztpraxen, Physiotherapien, Werkstätten, Umkleidekabinen
- Decken-, Wand und Abhängemontage
- Profil auf 200 cm freitragend
- Verwendung von Rollen möglich
- Spurbreite 6 mm
- Lagerlänge 7 m

LIEFERBARE FARBEN



weiß (RAL 9016)



silber (eloxiert)

STANDARDKOMPONENTEN

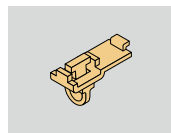
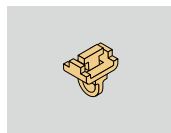

wird nur bei Ausklinkung geliefert

GLEITER WÄHLBAR (ohne Aufpreis)

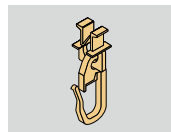
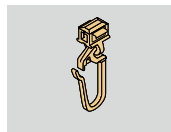

BELASTUNGSTABELLE

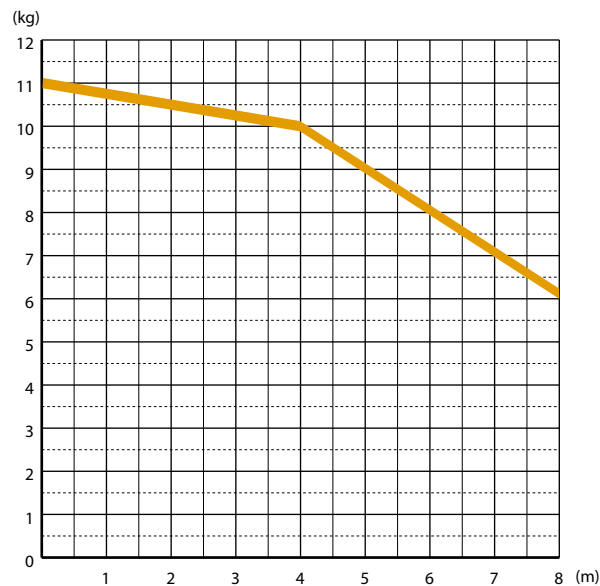

Bitte verwenden Sie bei schweren Vorhängen **Rollen** bzw. **Objektgleiter**.

Schiene ist kompatibel mit folgendem Wellenband

NEUAVE

LaOla.

Genauere Bezeichnung von Standardkomponenten und Gleitern, sowie weitere Gleiter finden Sie unter **Zubehör** (evtl. Mehrpreis beachten!).

MONTAGEMÖGLICHKEITEN

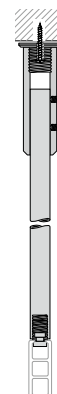
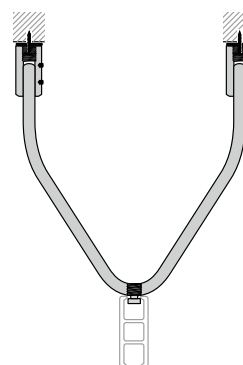
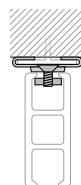
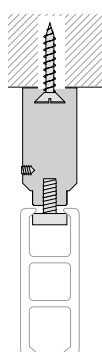
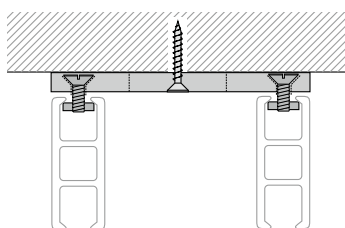
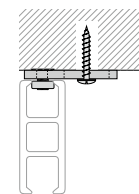

BIEGUNG



horizontale Biegung

mögliche Radien: **20 cm, ab 30 cm jeder Radius**

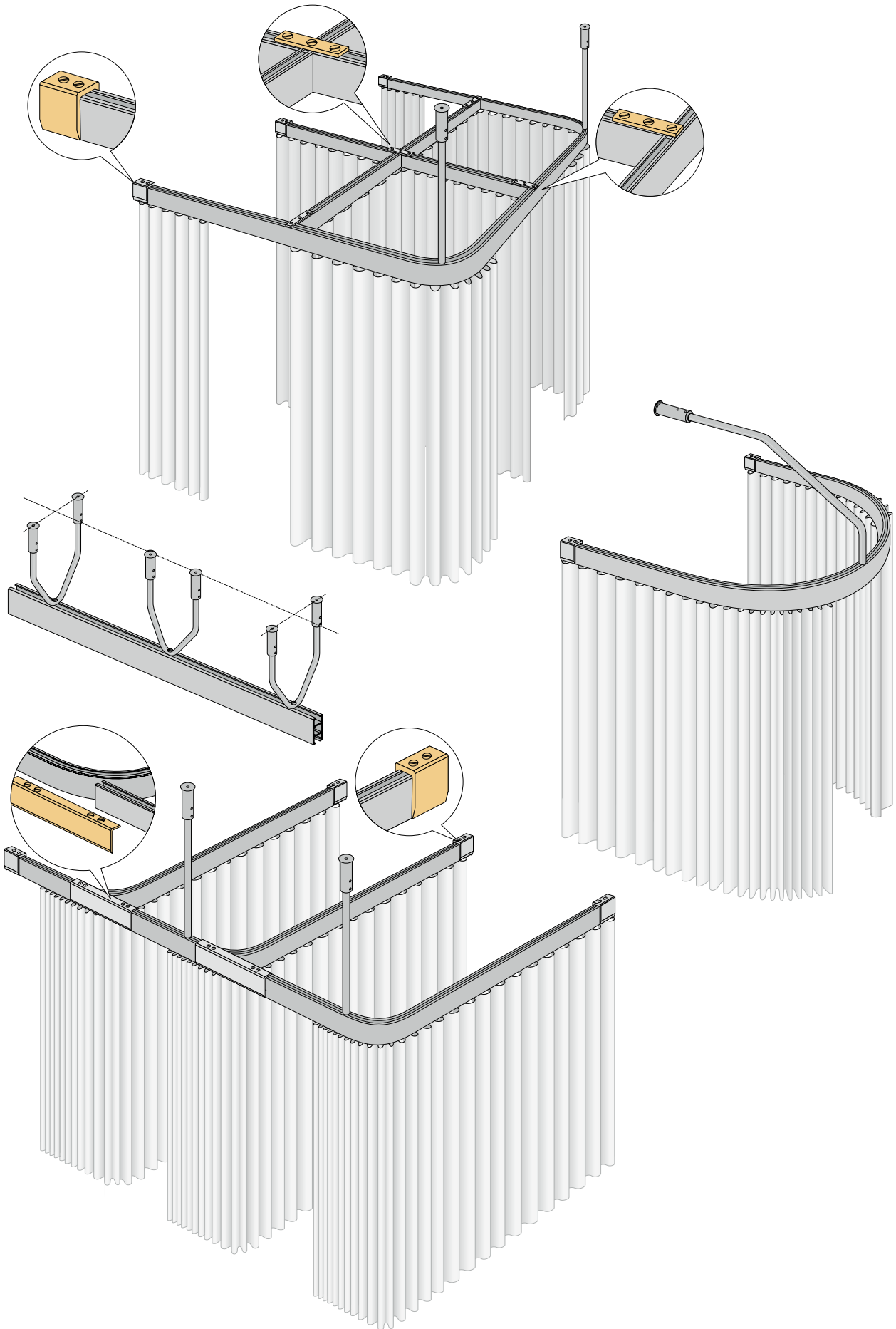

System 5100

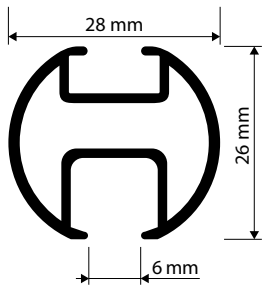

PRODUKTMERKMALE

- universell einsetzbares und stabiles Raumtrennprofil
- Einsatzbereich in Krankenhäusern, Arztpraxen, Physiotherapien, Werkstätten, Umkleidekabinen
- Decken-, Wand- und Abhängmontage
- Verwendung von Rollen möglich
- Spurbreite 6 mm
- Lagerlänge 7 m

LIEFERBARE FARBEN



weiß (RAL 9016)

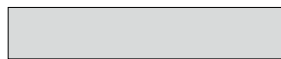

silber (eloxiert)

BELASTUNGSTABELLE

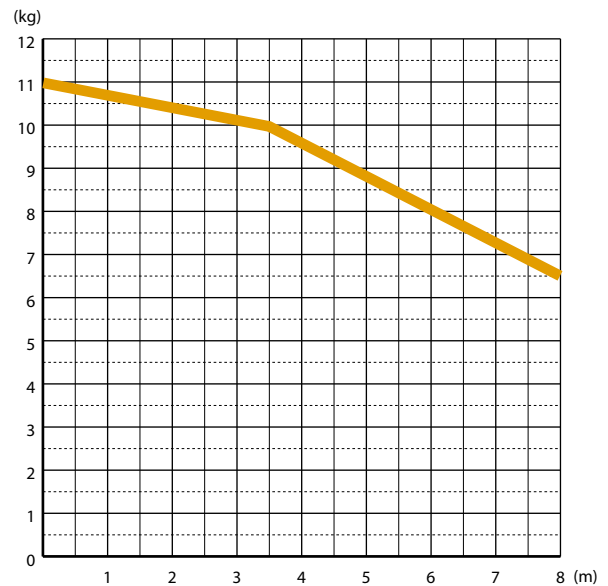

Bitte verwenden Sie bei schweren Vorhängen **Rollen bzw. Objektgleiter**.

STANDARDKOMPONENTEN

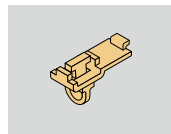
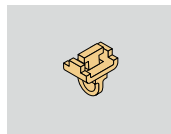

wird nur bei Ausklinkung geliefert

Schiene ist kompatibel mit folgendem Wellenband

NEUAVE

LaOla.

GLEITER WÄHLBAR (ohne Aufpreis)

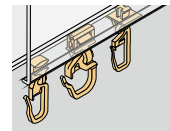
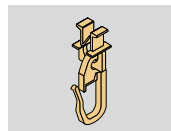
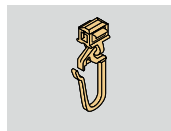

Genauere Bezeichnung von Standardkomponenten und Gleitern, sowie weitere Gleiter finden Sie unter **Zubehör** (evtl. Mehrpreis beachten!).

MONTAGEMÖGLICHKEITEN

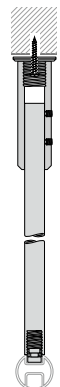
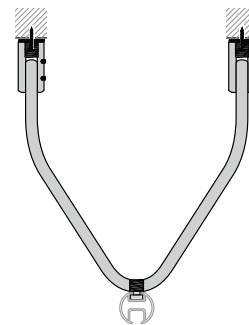
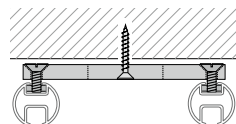
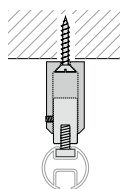
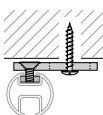

BIEGUNG



horizontale Biegung

mögliche Radien: **15 cm, ab 40 cm jeder Radius**



vertikale Biegung

mögliche Radien: **15 cm, ab 40 cm jeder Radius**

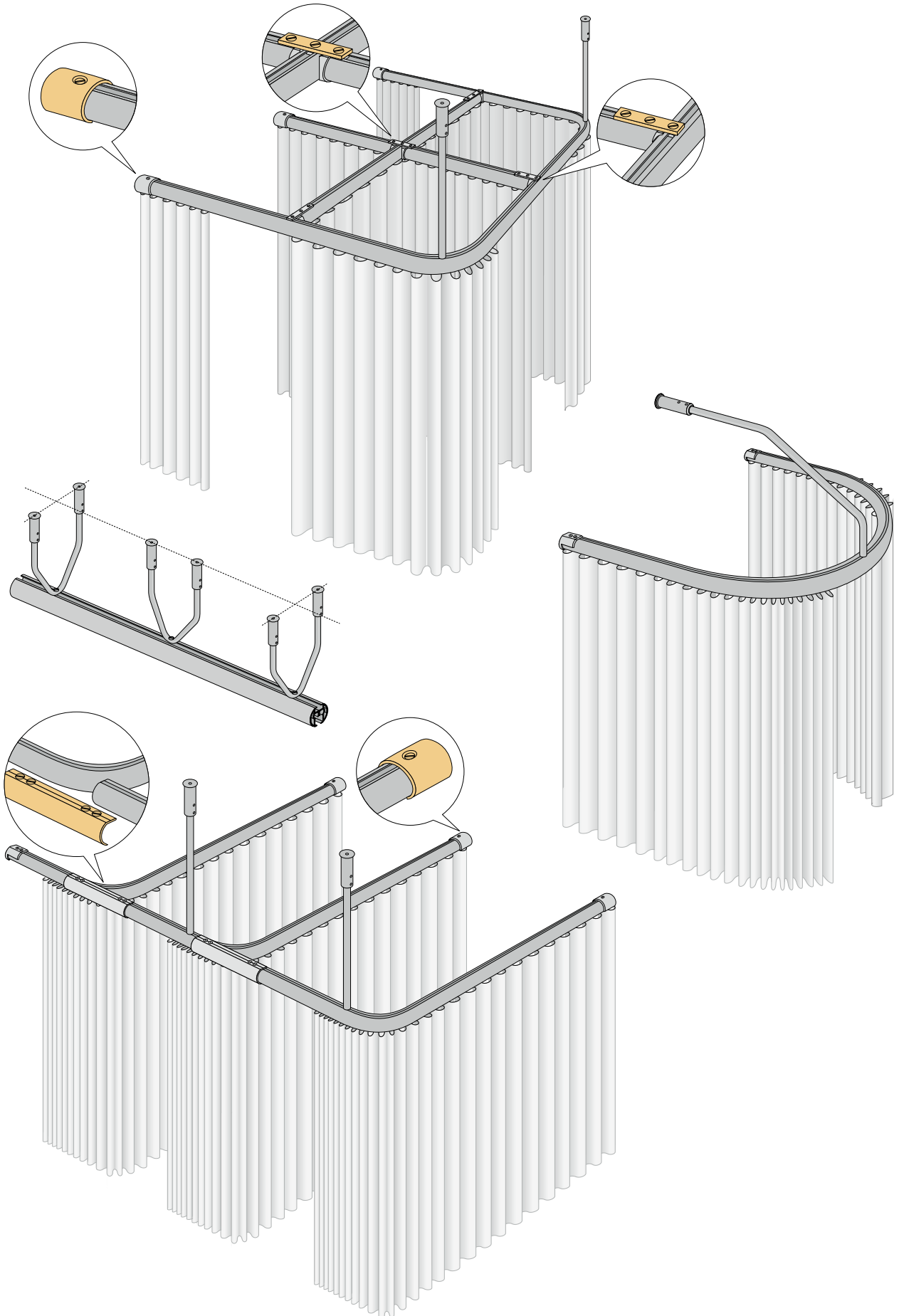

System 5200

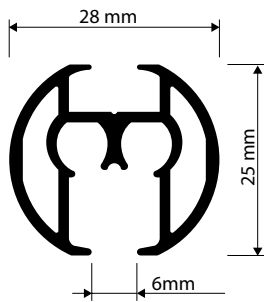

PRODUKTMERKMALE

- rundes und stabiles Schnurzugprofil aus Aluminium
- für Wohn- und Objektbereich einsetzbar
- Decken-, Wand- und Abhängemontage
- Spurbreite 6 mm
- Lagerlänge 6 m

LIEFERBARE FARBEN



weiß (RAL 9010)



silber (eloxiert)

STANDARDKOMPONENTEN

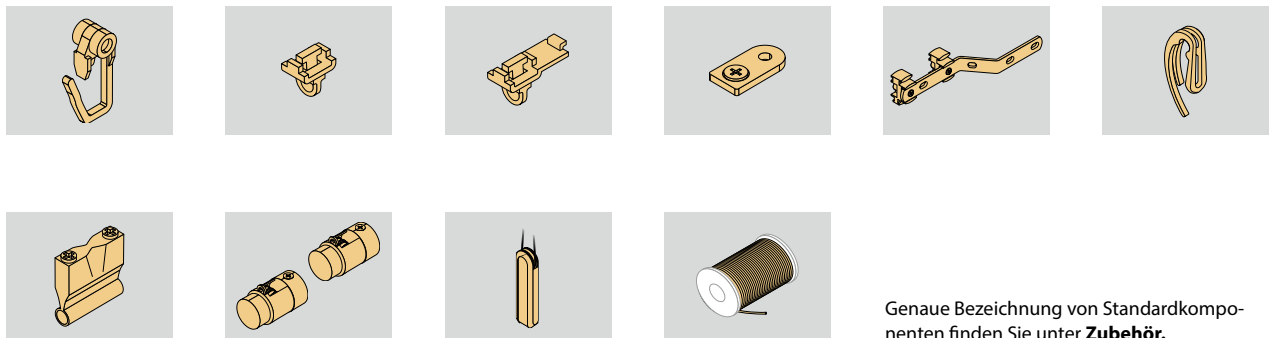

Genauere Bezeichnung von Standardkomponenten finden Sie unter **Zubehör**.

MONTAGEMÖGLICHKEITEN

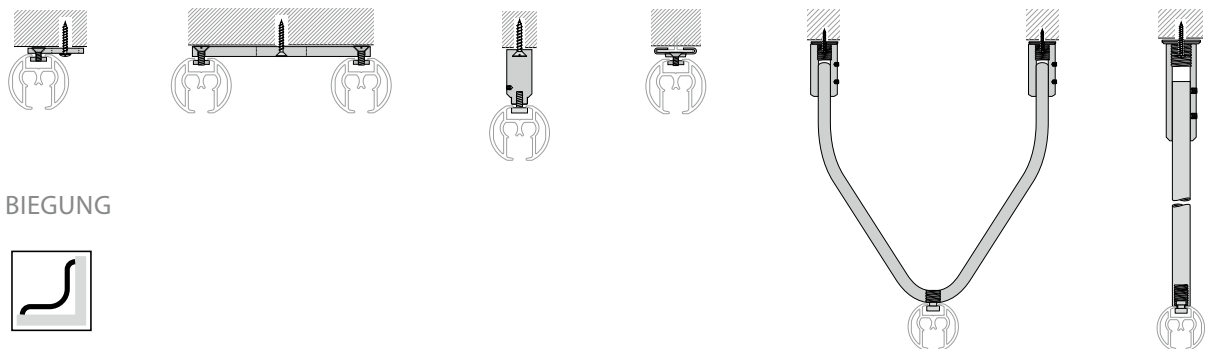

BIEGUNG



horizontale Biegung

mögliche Radien: **25 cm, ab 40 cm jeder Radius**

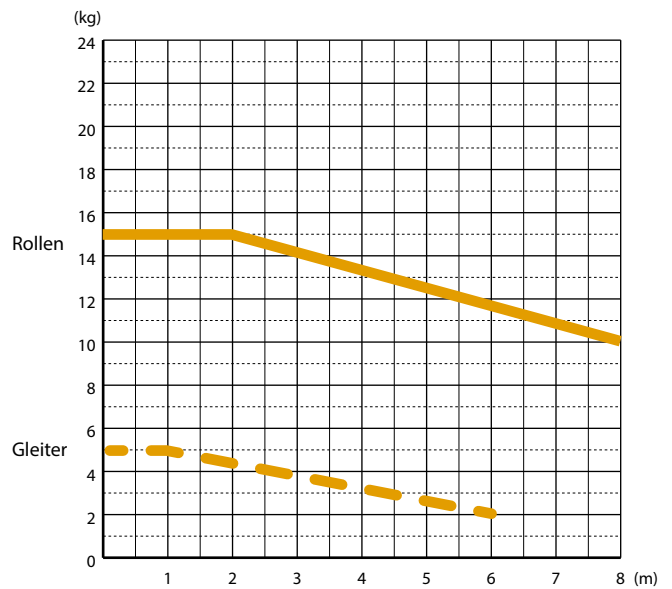
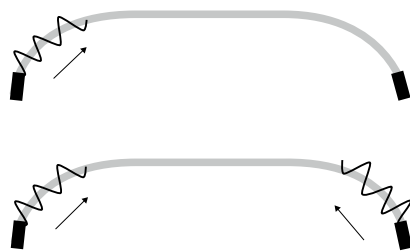
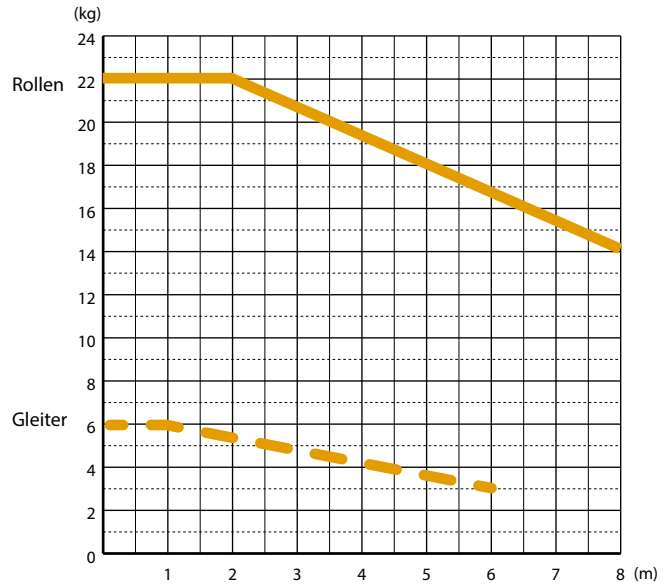
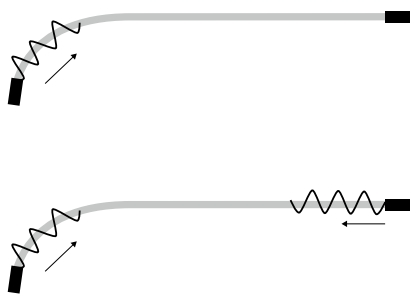
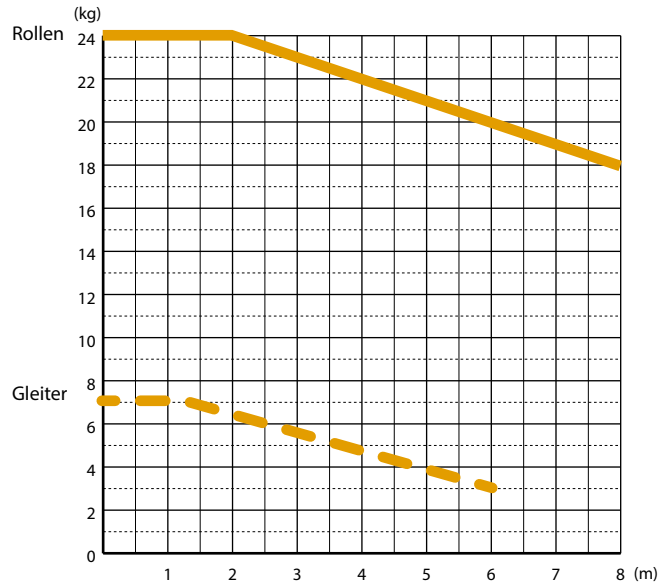

System 5500

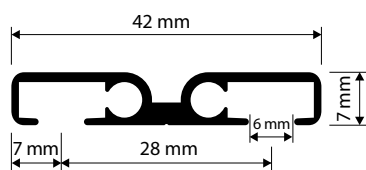

PRODUKTMERKMALE

- sehr flaches und dezentes Schnurzugprofil
- für den Wohnbereich einsetzbar
- Deckenmontage
- Spurbreite 6 mm
- Lagerlänge 6 m

LIEFERBARE FARBEN



weiß (RAL 9016)



silber (eloxiert)

STANDARDKOMPONENTEN

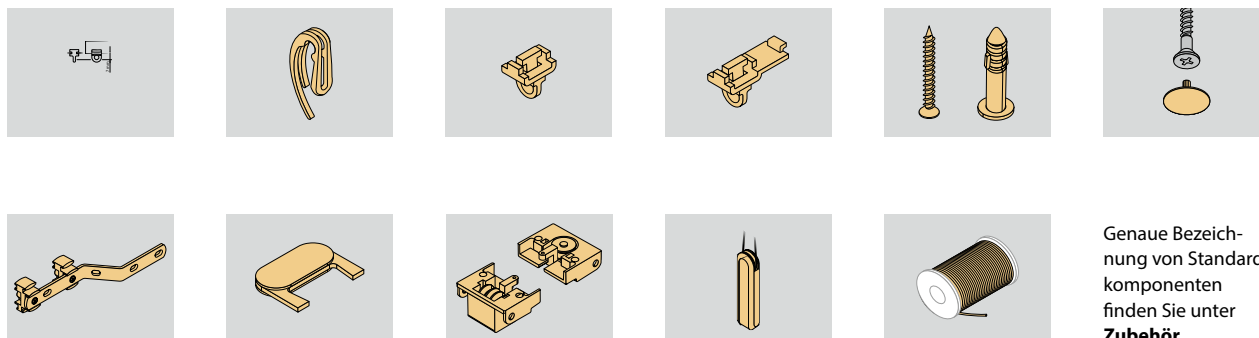

Genauere Bezeichnung von Standardkomponenten finden Sie unter **Zubehör**.

MONTAGEMÖGLICHKEITEN

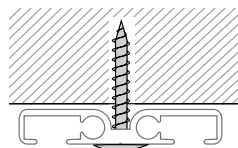

BIEGUNG



vertikale Biegung

mögliche Radien: **20 cm, ab 40 cm jeder Radius**

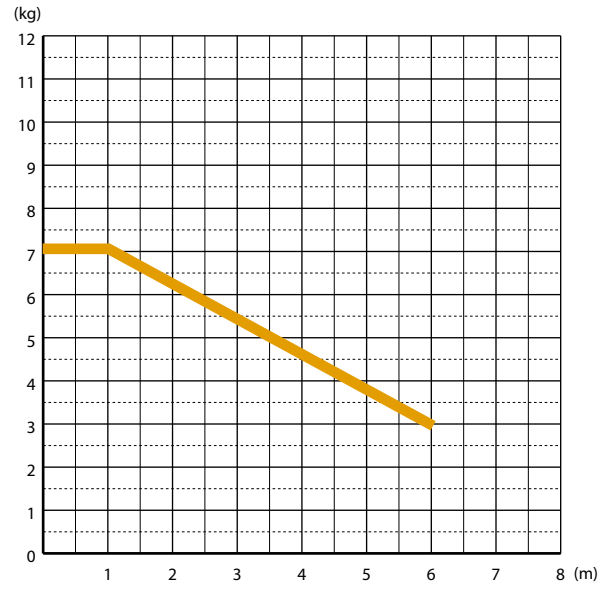

VERTIKAL GEBOGEN – TORBOGEN BZW. DACHSCHRÄGE

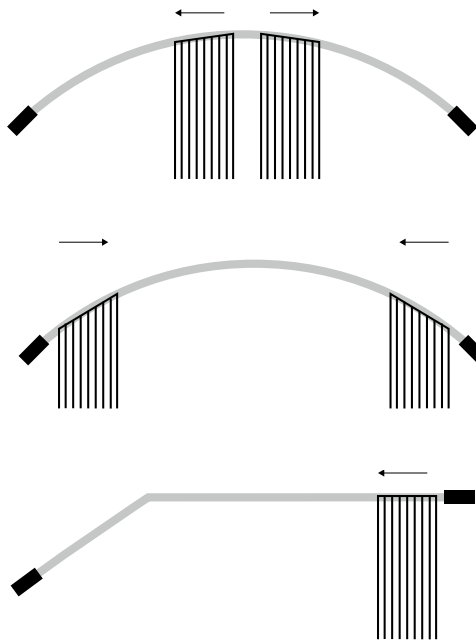

System 8100

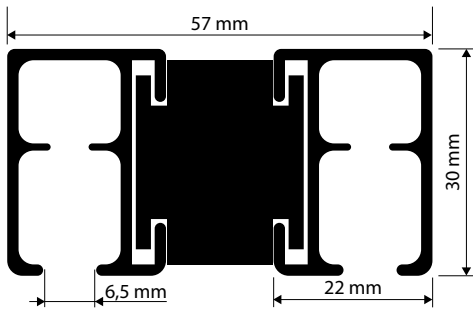

PRODUKTMERKMALE

- sehr stabile Seilzugschiene
- für Theater, Bühnen und Turnhallen einsetzbar
- Deckenmontage
- Spurbreite 6,5 mm
- Lagerlänge 6 m

LIEFERBARE FARBEN



weiß (RAL 9016)

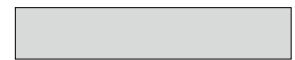

silber (eloxiert)

STANDARDKOMPONENTEN

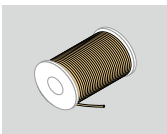
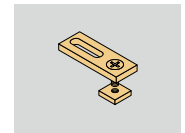
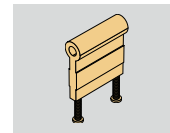
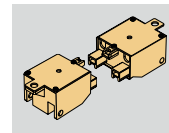
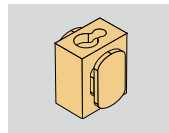

Genauere Bezeichnung von Standardkomponenten und Gleitern, sowie weitere Gleiter finden Sie unter **Zubehör** (evtl. Mehrpreis beachten!).

GLEITER WÄHLBAR



MONTAGEMÖGLICHKEITEN

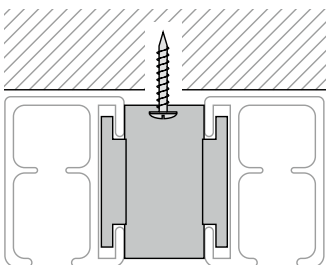

BIEGUNG



horizontale Biegung

mögliche Radien: **ab 40 cm jeder Radius**

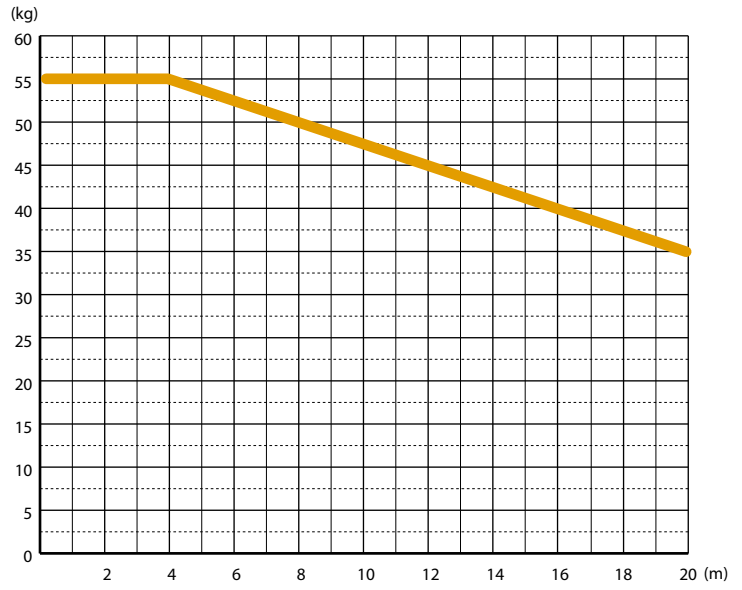

System 9500

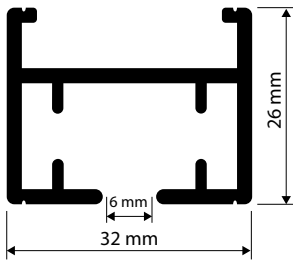

PRODUKTMERKMALE

- stabile Motor- / Kettenzugschiene für Wohn- und Objektbereich
- Deckenmontage mit Schnellspanner
- geräuscharmer Elektroantrieb
- 230 V Antrieb (Motorleistung zwischen 45 W oder 60 W wählbar, für schwere Behänge bzw. Anlangen über 7 m auch als Tandemausführung lieferbar)
- 24 V Antrieb mit TCS (Touch-Control-System, automatisches Verfahren des Behanges bei „Handbedienung“ verhindert Beschädigungen am System)
- Kettenzugbedienung max. 6 m
- Spurbreite 6 mm
- Lagerlänge 7 m

LIEFERBARE FARBEN



weiß (RAL 9016)

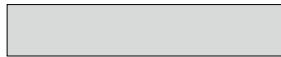

silber (eloxiert)

STANDARDKOMPONENTEN

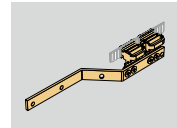
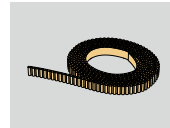
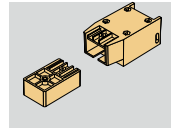
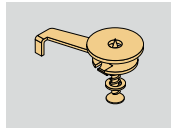
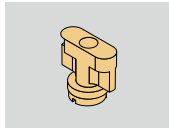

Genauere Bezeichnung von Standardkomponenten und Gleitern, sowie weitere Gleiter finden Sie unter **Zubehör** (evtl. Mehrpreis beachten!).

GLEITER WÄHLBAR



MONTAGEMÖGLICHKEITEN

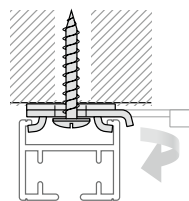

BIEGUNG



horizontale Biegung

mögliche Radien: **ab 45 cm jeder Radius**

BELASTUNGSTABELLEN (Angaben in kg)

gerade - Behang einteilig



gerade - Behang zweiteilig



1 Biegung / 90° - Behang einteilig



1 Biegung / 90° - Behang zweiteilig



2 Biegungen / 45° - Behang einteilig



2 Biegungen / 90° - Behang einteilig



2 Biegungen / 45° - Behang zweiteilig



2 Biegungen / 90° - Behang zweiteilig



Einzelantrieb 45 W

Länge	6 m	10 m	12 m	16 m
gerade	45	40	35	30
1 Biegung / 90°	40	35	30	
2 Biegungen / 45°	35	30	25	
2 Biegungen / 90°	30	25		

Tandem 45 W

Länge	6 m	10 m	12 m	16 m
gerade	60	55	40	35
1 Biegung / 90°	50	45	35	
2 Biegungen / 45°	50	40	30	
2 Biegungen / 90°	45	35	20	

Einzelantrieb 60 W

Länge	6 m	10 m	12 m	16 m
gerade	60	50	40	30
1 Biegung / 90°	50	45	40	30
2 Biegungen / 45°	45	35	25	
2 Biegungen / 90°	35	30		

Tandem 60 W

Länge	6 m	10 m	12 m	16 m
gerade	70	60	50	40
1 Biegung / 90°	60	50	45	40
2 Biegungen / 45°	50	45	30	25
2 Biegungen / 90°	45	40	30	

Einzelantrieb 230 V / 24 V

Länge	6 m	10 m	12 m	16 m
gerade	50	40	30	20
1 Biegung / 90°	40	30	20	
2 Biegungen / 45°	35	25		
2 Biegungen / 90°	25	20		

Kette

Länge	5 m	7 m		
gerade	25	20		
1 Biegung / 90°	20			

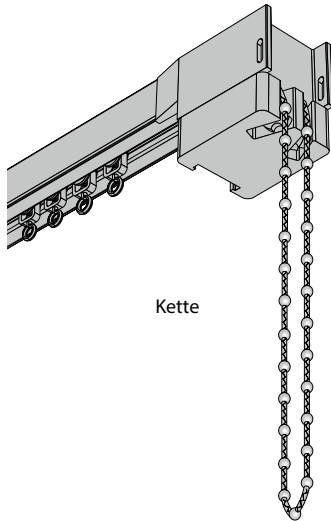

Kette

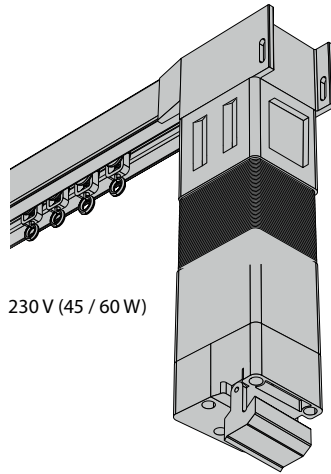

230 V (45 / 60 W)

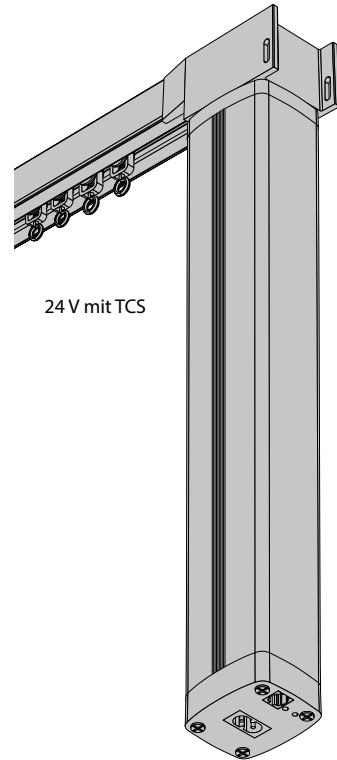

24 V mit TCS

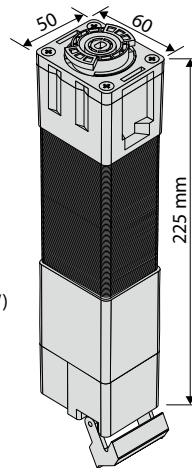

230 V (45 / 60 W)

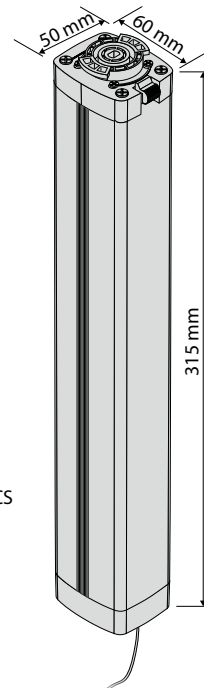

24 V mit TCS

	Motor 45 W	Motor 60 W	Motor 24 V – Vollautomatic
Netzspannung	230 V	230 V	230 V
Nennleistung	45 W	60 W	15 W
Nennstrom	0,195 A	0,195 A	0,8 A
Frequenz	50 Hz	50 Hz	50 Hz
Betriebsart	S3 30%	S3 30%	S3 50%
Schutzart	IP 41	IP 41	IP 41
Drehrichtung	re + li	re + li	re + li
Geschwindigkeit	5,6 m/min.	5,6 m/min.	9,6 m/min.
Tandem lieferbar	ja	ja	nein
TCS (Touch-Control-System)	nein	nein	ja

System 9550

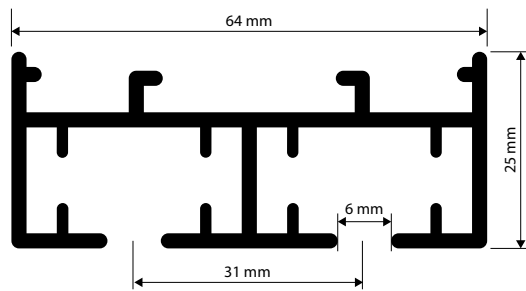

PRODUKTMERKMALE

- stabile 2-läufige Motor- / Kettenzugschiene für Wohn- und Objektbereich
- große Überlappungen möglich
- Deckenmontage mit Schnellspanner
- geräuscharmer Elektroantrieb
- 230 V Antrieb (Motorleistung zwischen 45 W oder 60 W wählbar, für schwere Behänge auch als Tandemausführung lieferbar)
- Kettenzugbedienung max. 6 m
- Spurbreite 6 mm
- Lagerlänge 7 m

LIEFERBARE FARBEN



weiß (RAL 9016)

STANDARDKOMPONENTEN

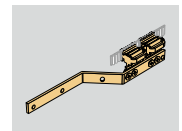
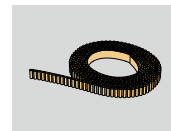
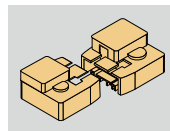
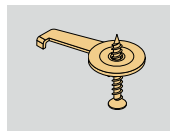
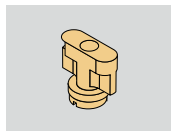

Genauere Bezeichnung von Standardkomponenten und Gleitern, sowie weitere Gleiter finden Sie unter **Zubehör** (evtl. Mehrpreis beachten!).

GLEITER WÄHLBAR

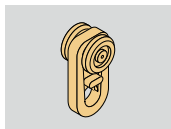

MONTAGEMÖGLICHKEITEN

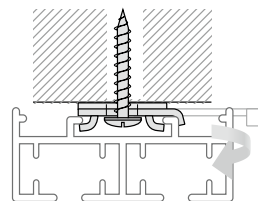

Motorschiene 9550

1-ANTRIEB

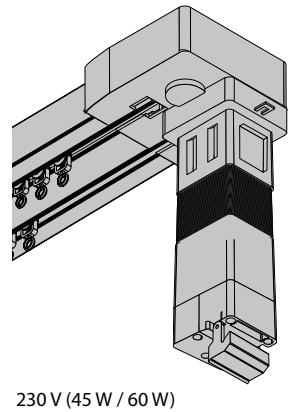
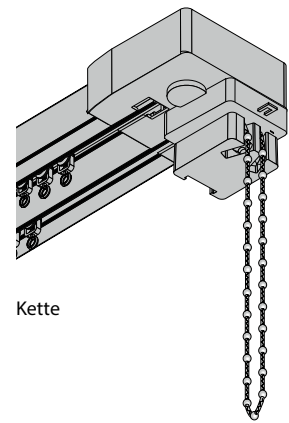
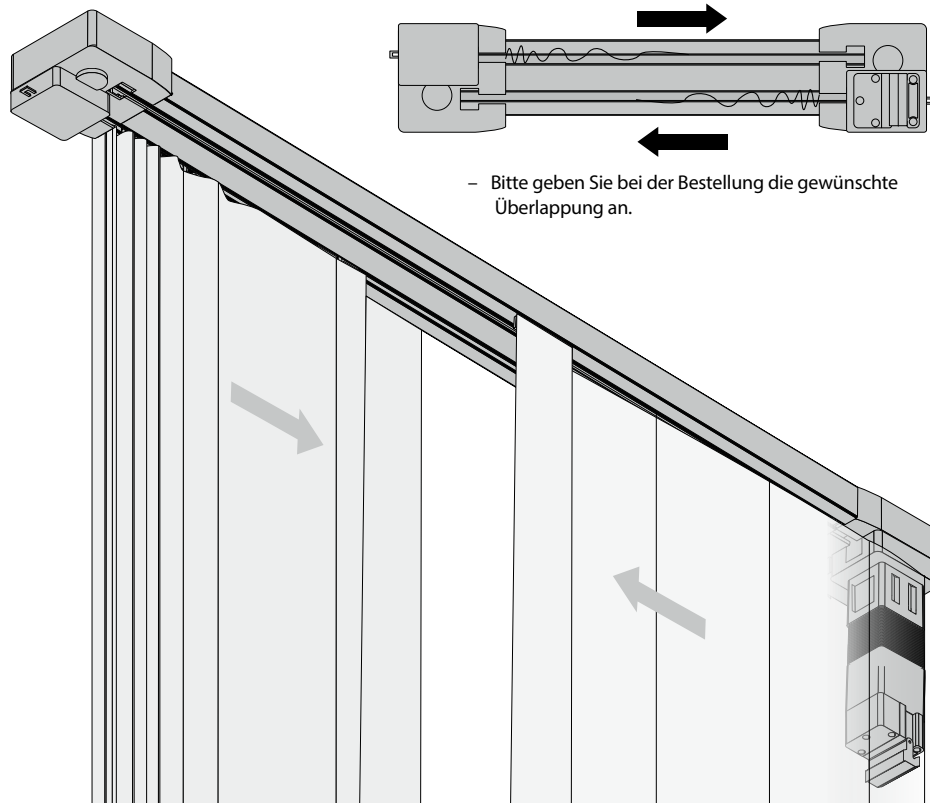

- die mittige Überlappung ist durch die individuelle Stoffbreite frei wählbar

TANDEM-ANTRIEB / 2-ANTRIEBE

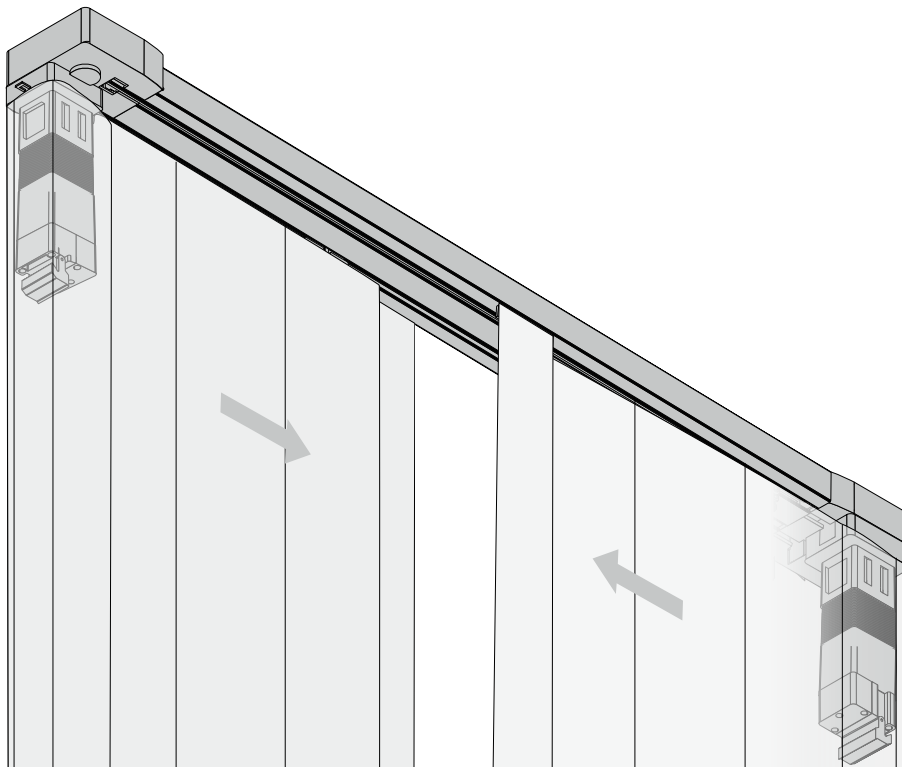

weitere Bedienmöglichkeit:

- durch zwei separat gesteuerte Motoren ist eine asymmetrische Behangteilung möglich
- die Überlappung ist durch die individuelle Stoffbreite frei wählbar

BELASTUNGSTABELLEN (Angaben in kg)

gerade - Behang einteilig



gerade - Behang zweiteilig

**Einzelantrieb 45 W**

Länge	6 m	10 m	12 m	16 m
gerade	45	40	35	30

Tandem 45 W

Länge	6 m	10 m	12 m	16 m
gerade	60	55	40	35

Einzelantrieb 60 W

Länge	6 m	10 m	12 m	16 m
gerade	60	50	40	30

Tandem 60 W

Länge	6 m	10 m	12 m	16 m
gerade	70	60	50	40

Einzelantrieb 230 V / 24 V

Länge	6 m	10 m	12 m	16 m
gerade	50	40	30	20

Kette

Länge	5 m	7 m		
gerade	25	20		

Motorscheine 9500/9550

EINZELBEDIENUNG MIT SCHALTER MOTOR 230 V

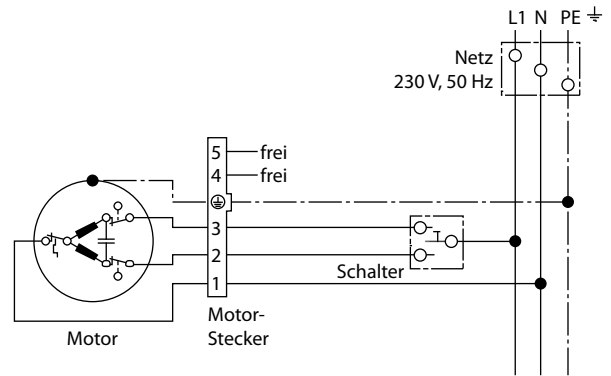
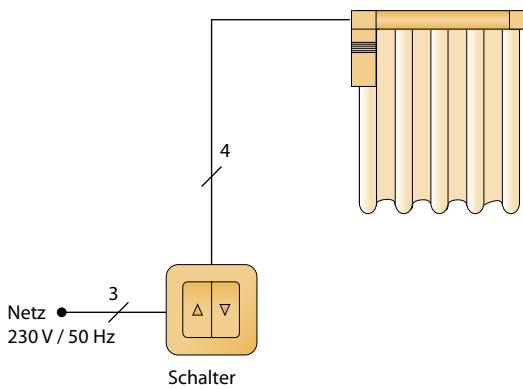

Benötigtes Elektrozubehör:

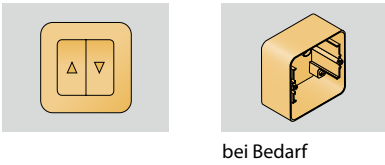

EINZELBEDIENUNG MIT TANDEM MOTOREN 230 V

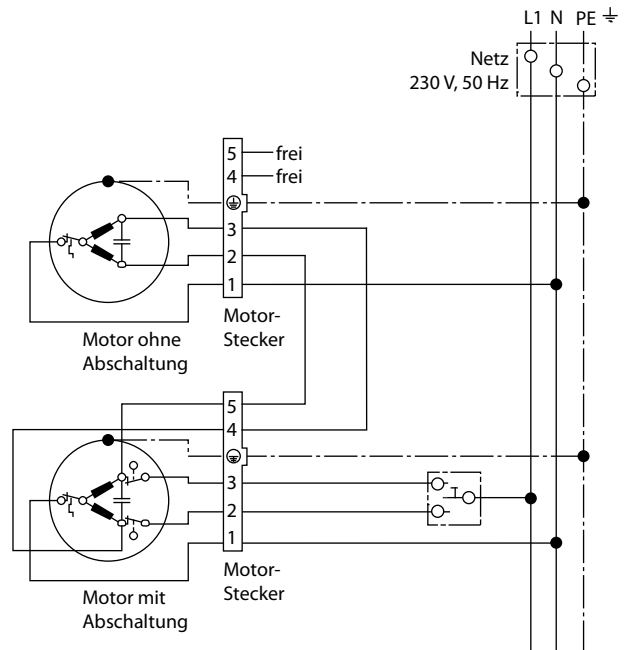
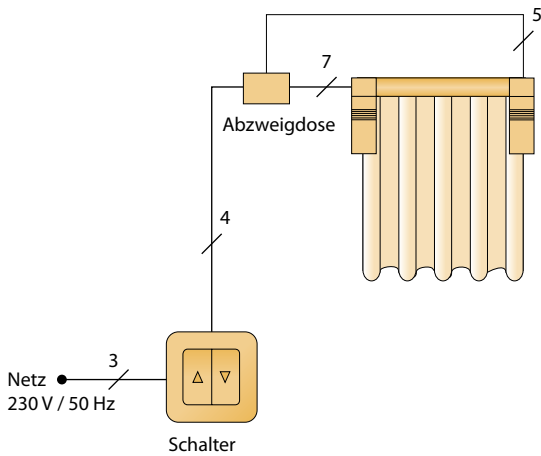

Benötigtes Elektrozubehör:

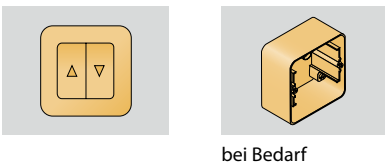

Weitere Schaltpläne erhältlich auf Anfrage.

GRUPPENBEDIENUNG MIT SCHALTER MOTOR 230 V

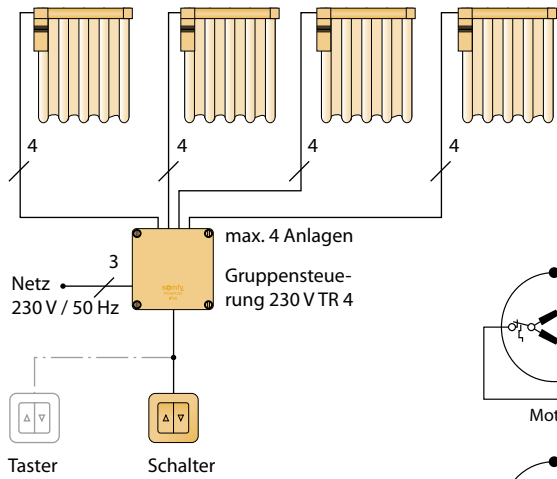

Benötigtes Elektrozubehör:



bei Bedarf



bei Bedarf

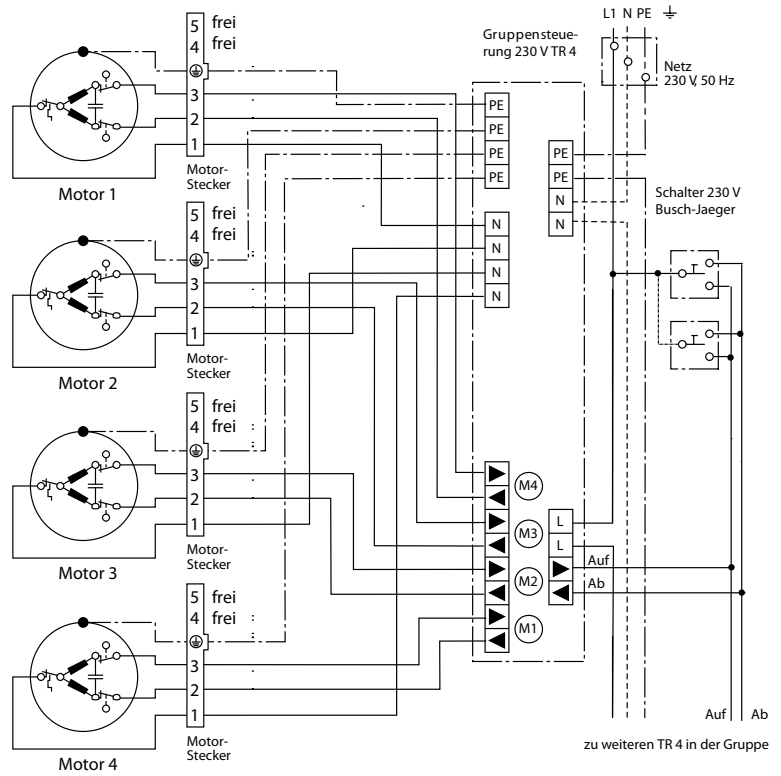

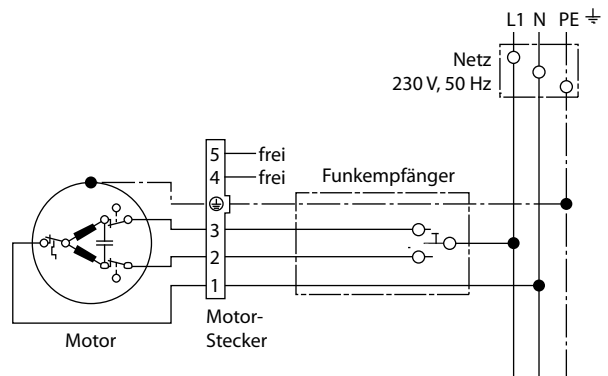
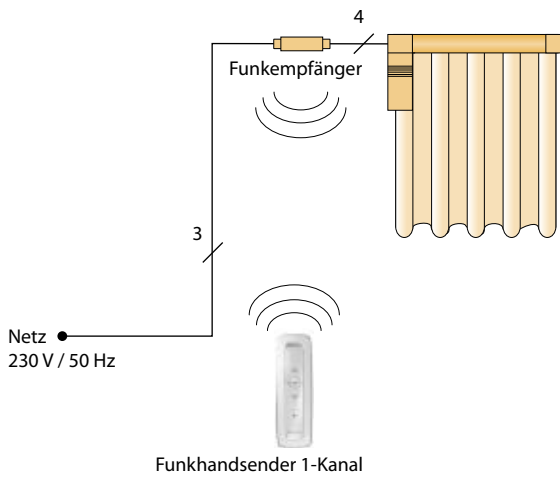

Benötigtes Elektrozubehör:

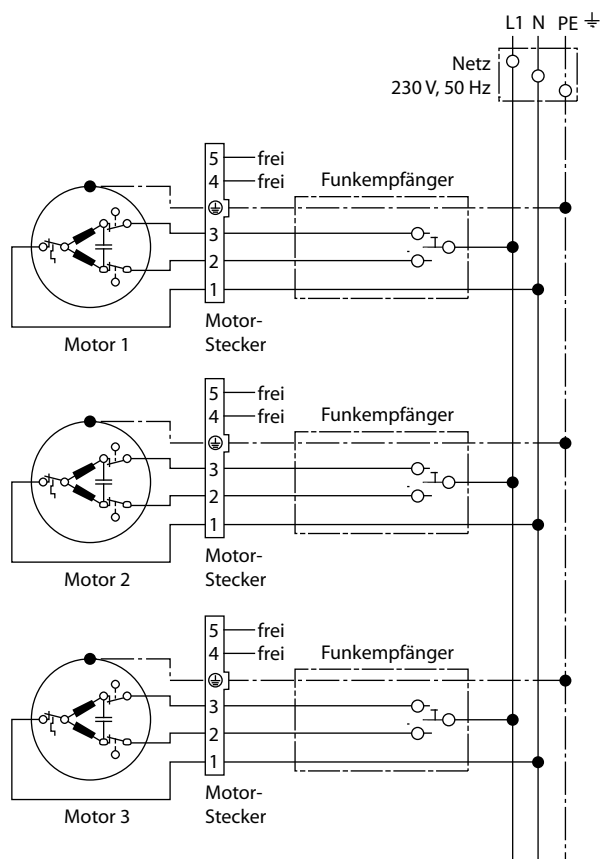
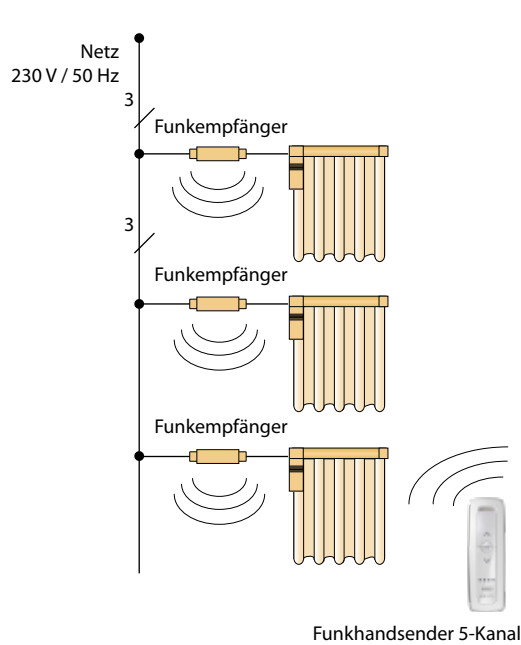
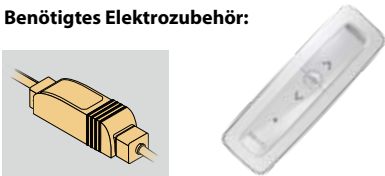

Benötigtes Elektrozubehör:



Weitere Schaltpläne erhältlich auf Anfrage.

System 2200

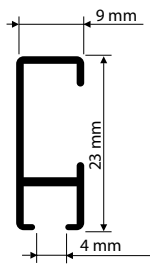

PRODUKTMERKMALE

- Profil mit hoher Stabilität und glatter Optik
- Wandmontage
- für professionelle Bilderpräsentation
- nachträglicher Einbau von Aufhängeseilen möglich
- Spurbreite 4 mm
- Lagerlänge 6 m

LIEFERBARE FARBEN



weiß (RAL 9016)



silber (eloxiert)

STANDARDKOMPONENTEN



Genauere Bezeichnung von Standardkomponenten finden Sie unter **Zubehör**.

MONTAGEMÖGLICHKEITEN

Wandclip (Standard)

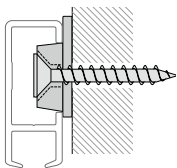

Deckenspanner (Mehrpreis beachten)



Schiene auflegen und Clip drehen

BILDERSETS

Bilderset bestehend aus:

- Bilderhaken
- Gleiter mit Nylonsehne (1,5 bzw. 2,5 m)

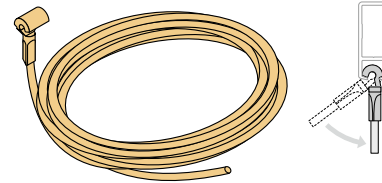

Hakengleiter „Cobra“ mit Nylonsehne 2 mm

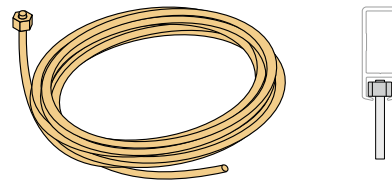

Sechskantgleiter mit Nylonsehne 2 mm

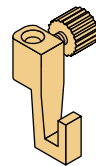

Bilderhaken 4 kg

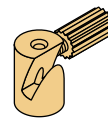

Bilderhaken 5 kg

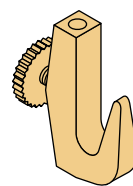

Bilderhaken 7 kg

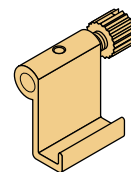

Bilderhaken 10 kg

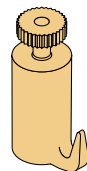

Bilderhaken 15 kg



ÜBERSICHT WANDWINKEL

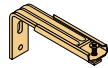

60 – 110 mm





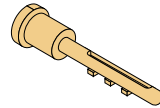



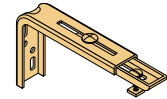

50, 70, 90, 160 mm



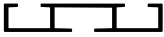

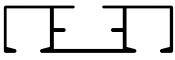



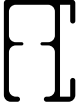
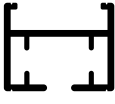
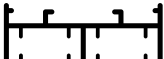









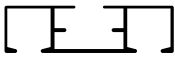

Kurz 95 mm
Lang 165 mm



Kurz 105 – 160 mm
Lang 150 – 240 mm

	60 – 110 mm	50, 70, 90, 160 mm	Kurz 95 mm Lang 165 mm	Kurz 105 – 160 mm Lang 150 – 240 mm
3600 		✓		
3700 	✓	✓	✓	
4300 	✓		✓	✓
4400 			✓	✓
4500 			✓ nur 4520	✓
4710 	✓	✓		
5000 	✓		✓	✓
5100 	✓		✓	✓
5200 				✓
8100 				✓
9500 				✓
9550 				✓

ÜBERSICHT GLEITER

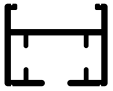
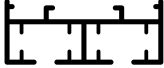
				
	A6 Teflongleiter mit Faltenhaken	A6 Teflongleiter mit drehbarem Faltenhaken	A6 Teflongleiter mit Öse für G- & Doppelhaken	A6 In-Out-Gleiter mit Faltenhaken
3600 	✓	✓	✓	✓
3700 	✓	✓	✓	✓
4100 	✓	✓	✓	✓
4300 	✓	✓	✓	✓
4400 	✓	✓	✓	✓
4500 	✓	✓	✓	✓
4600 	✓	✓	✓	✓
4700 	✓	✓	✓	✓
4710 	✓	✓	✓	✓
4850 	✓	✓	✓	✓
5000 	✓	✓	✓	✓
5100 	✓	✓	✓	✓
5200 				
5500 				
8100 				
9500 				
9550 				

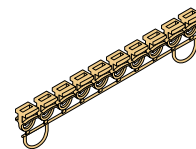

A6 Clic-Gleiter mit Faltenhaken kurz

A6 Clic-Gleiter mit Faltenhaken lang

A6 Clic-Gleiter mit Öse für G- und Doppelhaken

A6 Objekt-Gleiter in Reihe á 10 Stück

3600		✓	✓	✓	✓
3700		✓	✓	✓	✓
4100		✓	✓	✓	✓
4300		✓	✓	✓	✓
4400		✓	✓	✓	✓
4500		✓	✓	✓	✓
4600		✓	✓	✓	✓
4700		✓	✓	✓	✓
4710		✓	✓	✓	✓
4850		✓	✓	✓	✓
5000		✓	✓	✓	✓
5100		✓	✓	✓	✓
5200					
5500					
8100					
9500					
9550					



A6 Objekt-Gleiter

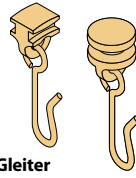

A6 Gleiter
mit Metallhaken



Rolle mit Schwenköse



Schwerlastrolle

	A6 Objekt-Gleiter	A6 Gleiter mit Metallhaken	Rolle mit Schwenköse	Schwerlastrolle
3600	✓	✓		
3700	✓	✓		
4100	✓	✓		
4300	✓	✓		
4400	✓	✓		
4500	✓	✓		
4600	✓	✓		
4700	✓	✓		
4710	✓	✓		
4850	✓	✓		
5000	✓	✓		
5100	✓	✓		
5200				
5500	✓			
8100			✓	✓
9500			✓	✓
9550			✓	✓

Zubehör

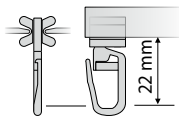
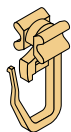

A6 Teflongleiter mit Faltenhaken
für 6 mm Aluschiene, Kunststoff, weiß

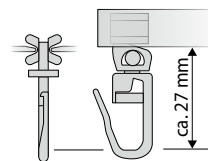
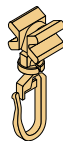

A6 Teflongleiter mit drehbarem Faltenhaken
für 6 mm Aluschiene, Kunststoff, weiß

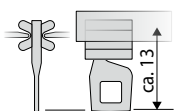
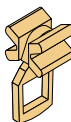

A6 Teflongleiter mit Öse für G- & Doppelhaken
für 6 mm Aluschiene, Kunststoff, weiß

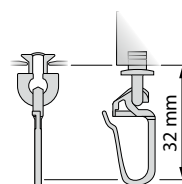
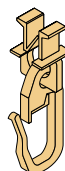

A6 In-Out-Gleiter mit Faltenhaken
für 6 mm Aluschiene, Kunststoff, weiß

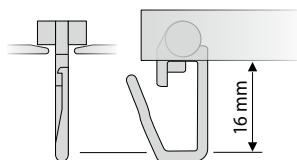
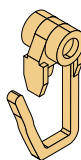

A6 Objekt-Rolle mit Faltenhaken
für 6 mm Aluschiene, Kunststoff, weiß

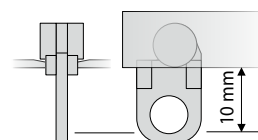

A6 Objekt-Rolle mit Öse für G- und Doppelhaken
für 6 mm Aluschiene, Kunststoff, weiß

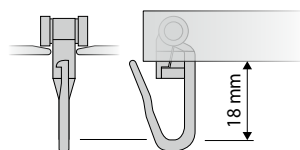
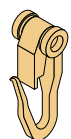

A6 Rolle mit Faltenhaken
für 6 mm Aluschiene, Kunststoff, weiß

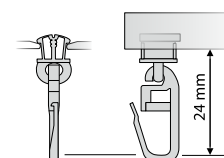

A6 Switchgleiter mit Faltenhaken kurz
für 6 mm Aluschiene, Kunststoff, weiß



Clic™
DAS ORIGINAL

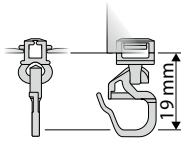

A6 Clic-Gleiter mit Faltenhaken kurz
für 6 mm Aluschiene, Kunststoff, weiß



Clic™
DAS ORIGINAL

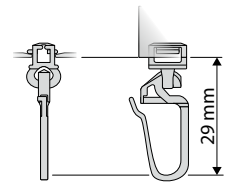

A6 Clic-Gleiter mit Faltenhaken lang
für 6 mm Aluschiene, Kunststoff, weiß



Clic™
DAS ORIGINAL

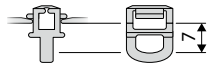

A6 Clic-Gleiter mit Öse für G- und Doppelhaken
für 6 mm Aluschiene, Kunststoff, weiß

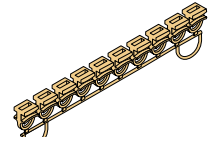
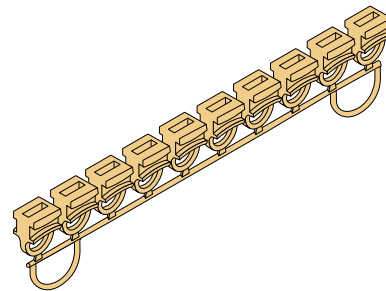

A6 Objekt-Gleiter in Reihe á 10 Stück
für 6 mm Aluschiene, Kunststoff, weiß

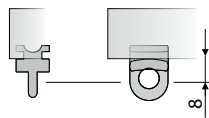

A6 Objekt-Gleiter
für 6 mm Aluschiene, Kunststoff, weiß



Doppelhaken Metall
Metall, silber

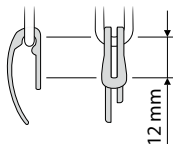
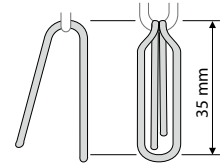

Doppelhaken
Kunststoff, weiß

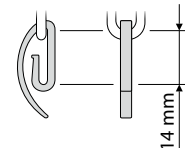

G-Haken
Kunststoff, weiß

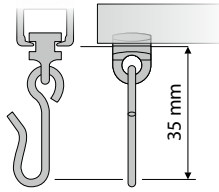

A6 Gleiter mit Metallhaken
für 6 mm Aluschiene, Kunststoff-Metall, weiß-silber

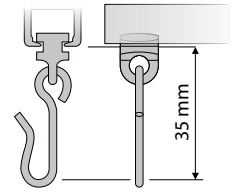

A6 Rundkopfleiter mit Metallhaken
für 6 mm Aluschiene, Kunststoff-Metall, weiß

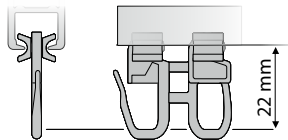
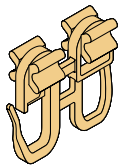

A6 Schleudergleiter mit Faltenhaken
für 6 mm Aluschiene, Kunststoff, weiß

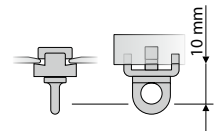
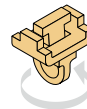

A6 Feststeller
für 6 mm Aluschiene, Kunststoff, weiß

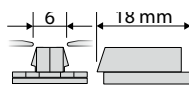
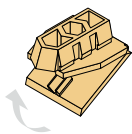

A6 Clic-Feststeller
für 6 mm Aluschiene, Kunststoff, weiß

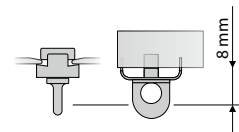

A6 Feststeller mit Metallplatte
für 6 mm Aluschiene, Kunststoff/Metall, weiß-silber



A6 Feststeller mit Metallplatte
für 6 mm Aluschiene, Metall, silber

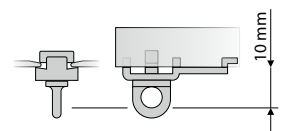
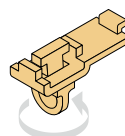

A6 Verschlussfeststeller
für 6 mm Aluschiene, Kunststoff, weiß

Zubehör

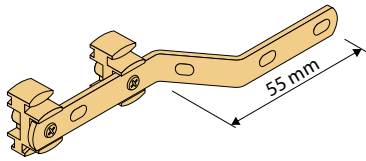

Überzugwagen mit Metallarm

für 6 mm Aluschiene, Kunststoff-Metall, weiß-silber

SONSTIGE LAUFBREITE

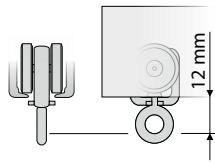

Rolle mit Schwenköse

mit Stahlachse, nur mit Doppelhaken Metall kombinierbar, Kunststoff, hellgrau

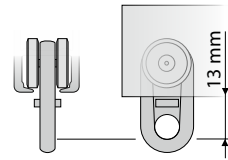

Schwerlastrolle

mit Stahlachse, nur mit Doppelhaken Metall kombinierbar, Kunststoff, hellgrau

WANDWINKEL

Wandwinkel 50 mm

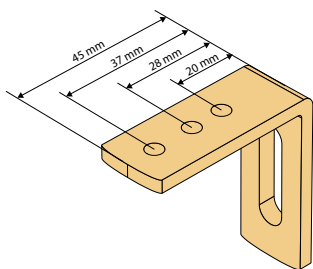

Wandwinkel Metall 50 mm
erhältlich in weiß und silber

Wandwinkel Metall 120 mm
erhältlich in weiß

Wandwinkel Metall 70 mm
erhältlich in weiß und silber

Wandwinkel Metall 140 mm
erhältlich in weiß

Wandwinkel Metall 90 mm
erhältlich in weiß und silber

Wandwinkel Metall 160 mm
erhältlich in weiß und silber

Wandwinkel 70 mm

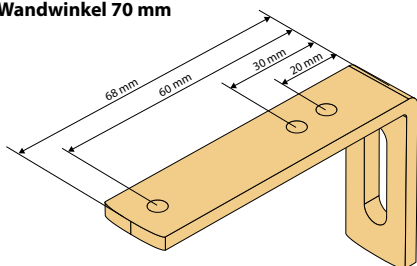

Abdeckung für Wandwinkel

Kunststoff, erhältlich in weiß und grau

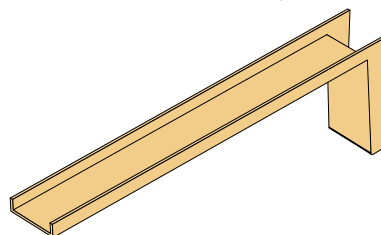

Wandwinkel 90 mm

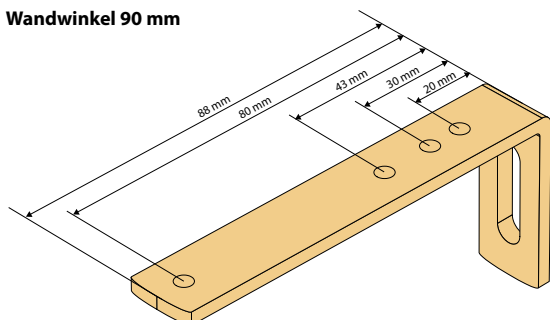

Wandwinkel 120 mm

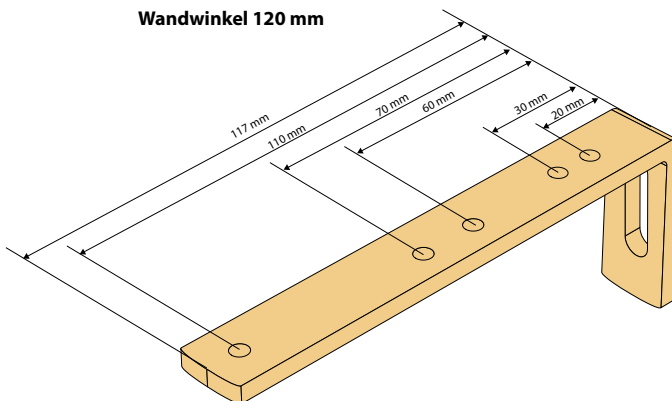

Wandwinkel 140 mm

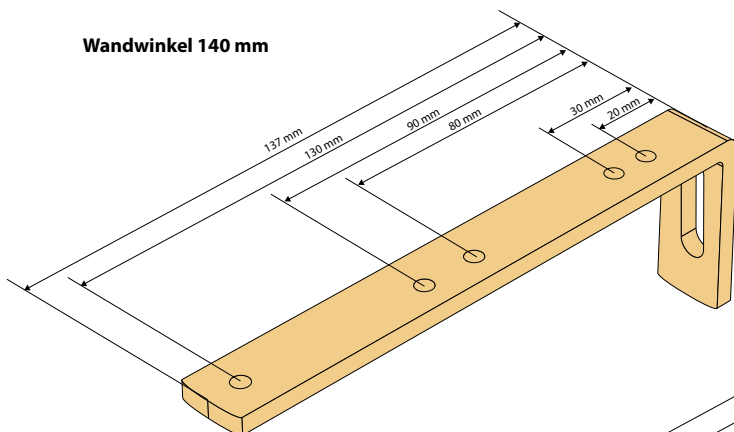

Wandwinkel 160 mm

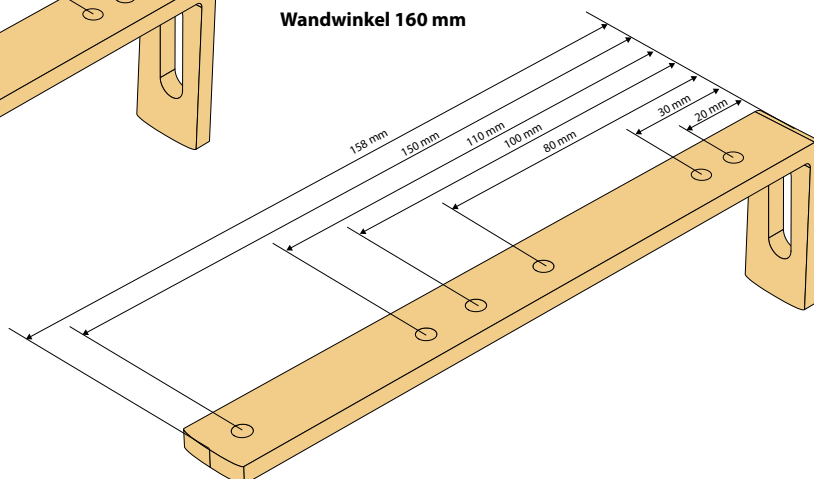

Zubehör

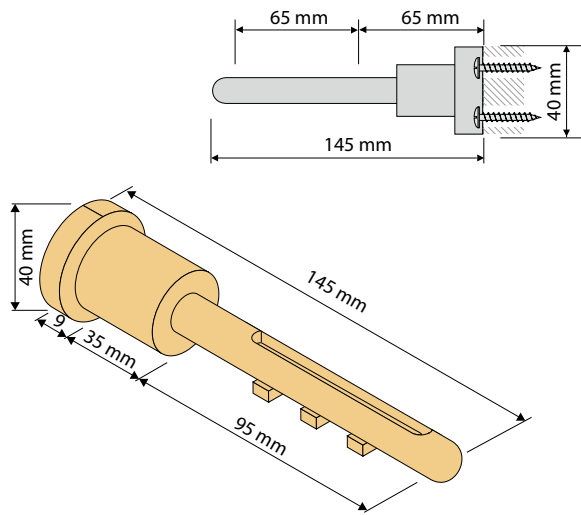

Wandträger „Multi“ kurz

kürzbar, Aluminium, erhältlich in weiß, messing matt, silber, edelstahlfarben

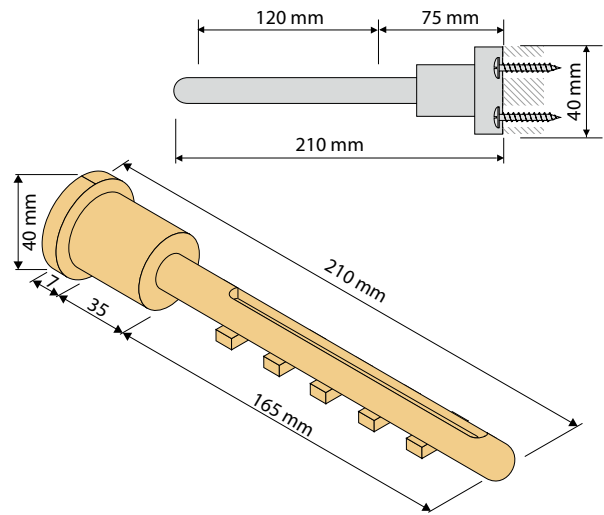

Wandträger „Multi“ lang

kürzbar, Aluminium, erhältlich in weiß, messing matt, silber, edelstahlfarben

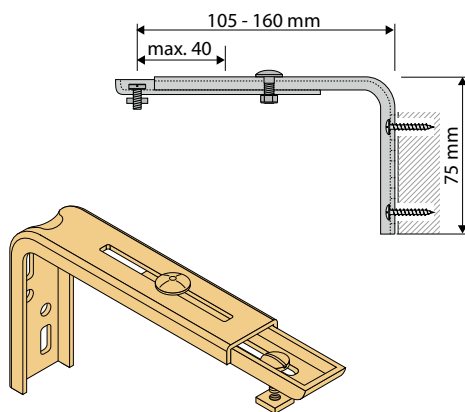

Wandwinkel

Verstellbereich 105-160 mm, Metall, erhältlich in weiß und silber

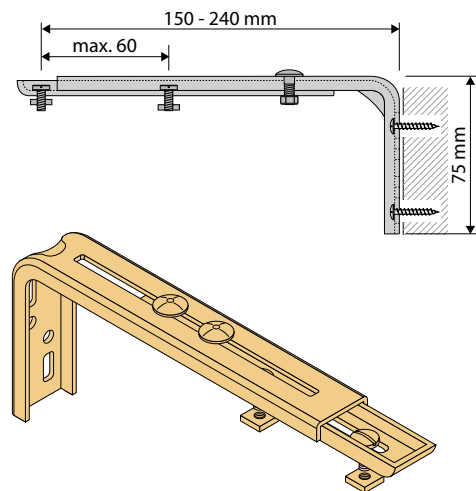

Wandwinkel

Verstellbereich 150-240 mm, Metall, erhältlich in weiß und silber

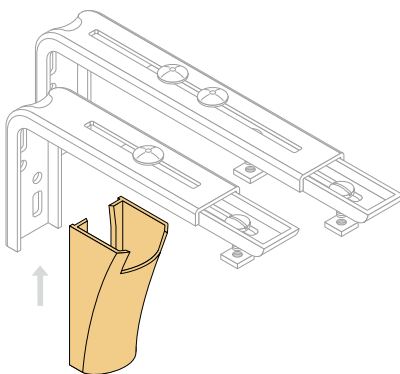

Abdeckkappe

für Wandwinkel, Kunststoff, erhältlich in weiß und grau

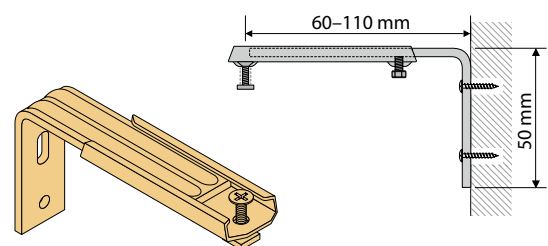

Wandwinkel

Verstellbereich 60-110 mm, Metall, erhältlich in weiß und silber

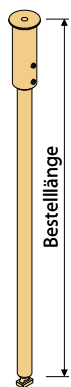

Abhänger Ø 15

min. Bestellhöhe: 105 mm, Metall, erhältlich in weiß und silber

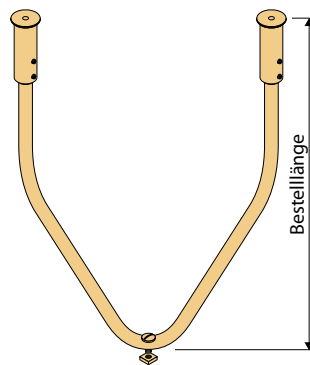
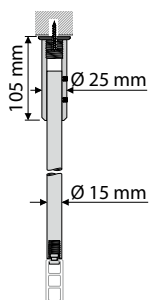

V-Abhänger Ø 15

min. Bestellhöhe: 300 mm, Metall, erhältlich in weiß und silber

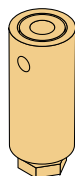
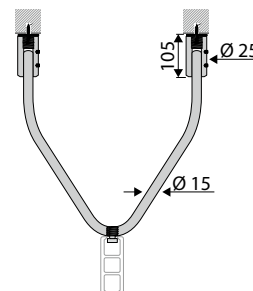

Deckenträger 30 mm

Metall, erhältlich in weiß und silber

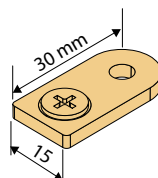
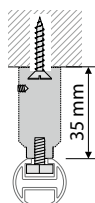

Deckenträger

Metall, erhältlich in weiß und silber

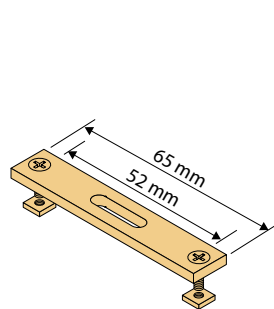
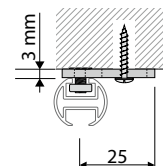

Doppelträger

Metall, erhältlich in weiß und silber

