

Hand operated rail 4300

Aluminium rails

System 4300

RAIL 4320

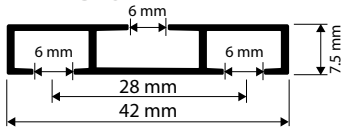

RAIL 4340

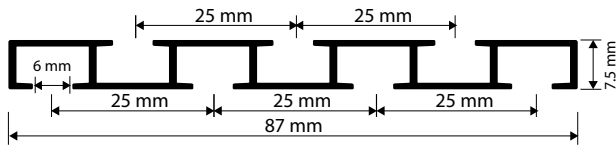

PRODUCT FEATURES

- Extra flat aluminium profile
- Rail can be used as 1 / 2 track or 3 / 4 track rail
- Ceiling fixation
- Track width 6 mm
- Bearing length 6 mm

AVAILABLE COLOURS

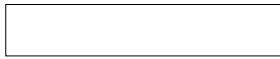

White (RAL 9016)



Silver (RAL 9006)

LOAD TABLE

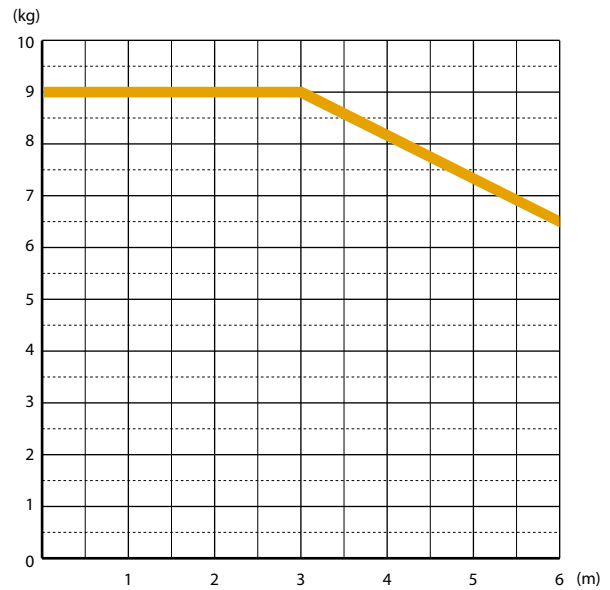

Please use **object gliders** for heavy curtains.

STANDARD COMPONENTS



SELECTABLE GLIDERS



For the exact designation of standard components and gliders and for more gliders refer to **Accessories**.

ASSEMBLY OPTIONS

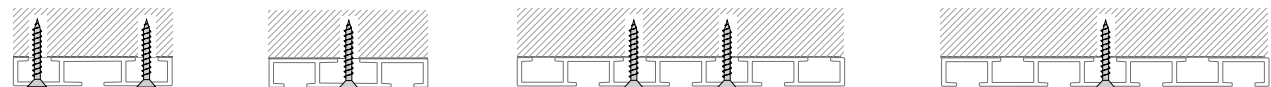

RETURN CURVE



Return curve for 4320

Possible radii: **20 cm**

CURVE



Horizontal curve for 4320

Possible radii: **20 cm, from 40 cm any radius possible**



Vertical curve for 4320

Possible radii: **20 cm, from 40 cm any radius possible**

RETURN CURVE

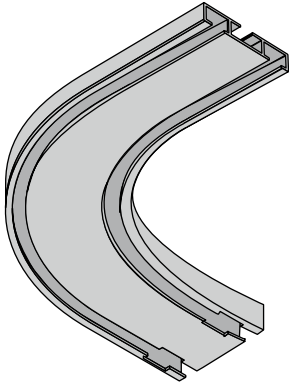

Model 4320

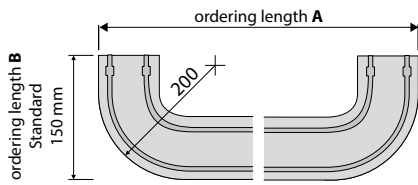

MITRE CUT

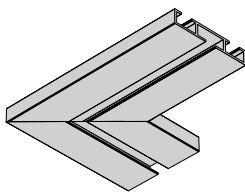

Model 4320 – 1-track

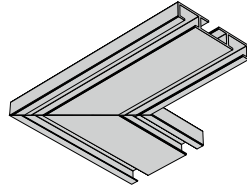

Model 4320 – 2-track

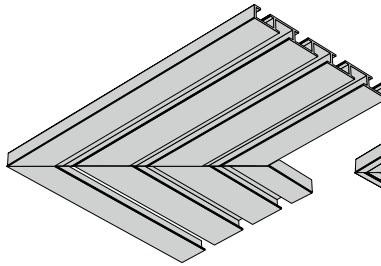

Model 4340 – 3-track

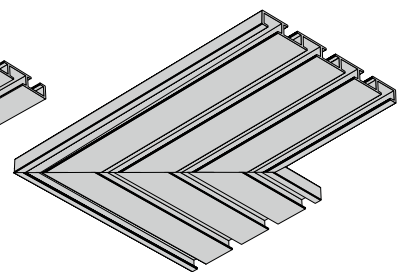

Model 4340 – 4-track

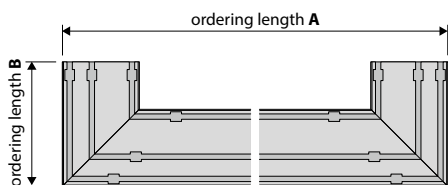

Mitre cut 4320 incl. 1 corner connector
Mitre cut 4340 incl. 2 corner connectors

Hand operated rail 4400

Aluminium rails

System 4400

RAIL 4410

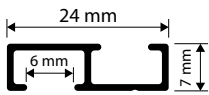

RAIL 4420

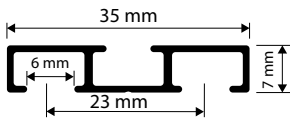

RAIL 4425

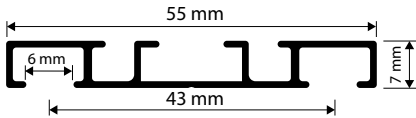

RAIL 4430

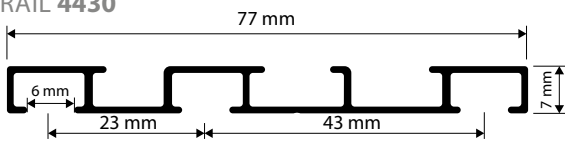

LOAD TABLE

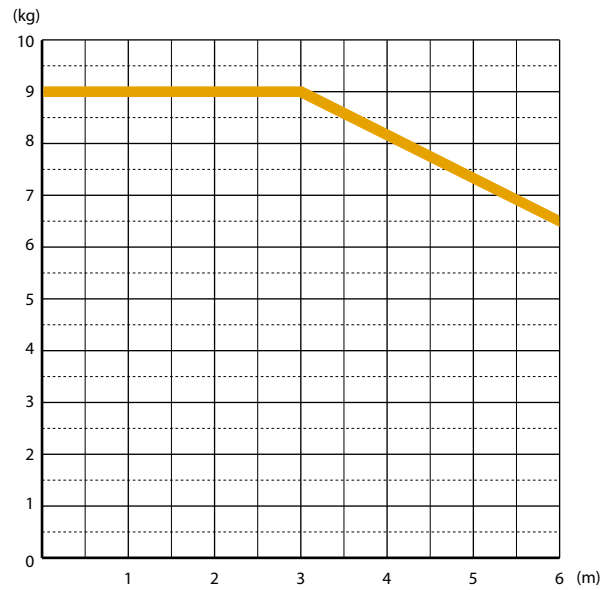

PRODUCT FEATURES

- Extra flat aluminium profile
- Different track variants with the same look
- Suitable for objects
- For ceiling fixation
- Track width 6 mm
- Bearing length 6 m



Please use **object gliders** for heavy curtains.

AVAILABLE COLOURS



White (RAL 9016)



Silver (anodized)

STANDARD COMPONENTS



SELECTABLE GLIDERS (Without extra charge)



For the exact designation of standard components and gliders and for more gliders refer to **Accessories**.

ASSEMBLY OPTIONS

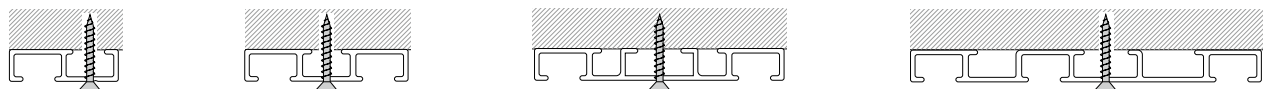

RETURN CURVE



Possible radii: **10 cm, 15 cm (please note curve type)**

CURVE



Horizontal curve

Possible radii: **10 cm, 15 cm, from 40 cm any radius possible (please note curve type)**



Vertical curve

For 4410 and 4420
Possible radii: **20 cm, from 40 cm any radius possible**

Hand operated rail 4400

Aluminium rails

RETURN CURVE

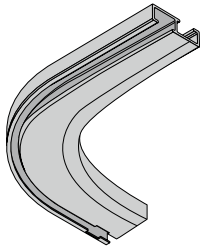

Model 4410

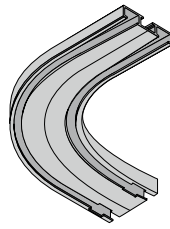

Model 4420

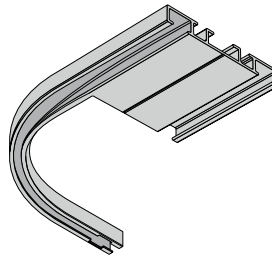

Model 4425

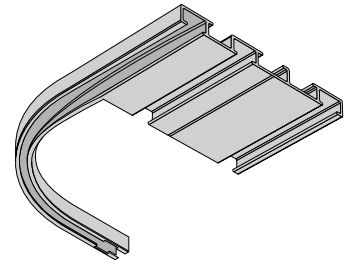

Model 4430

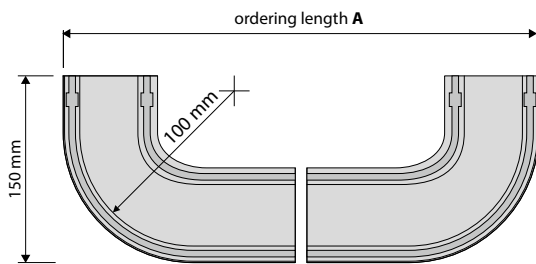

Return curve 4410/4420

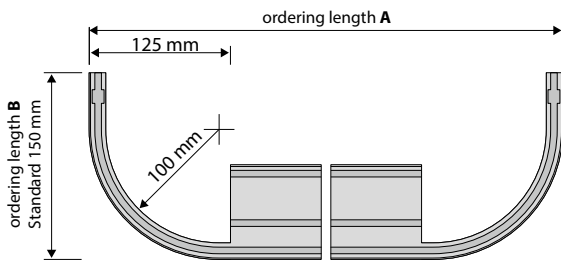

Return curve 4425/4430

MITRE CUT

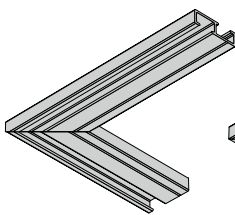

Model 4410

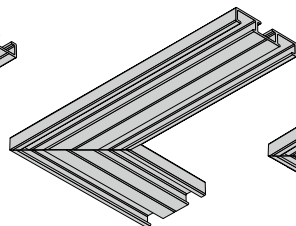

Model 4420

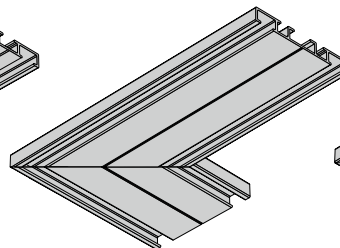

Model 4425

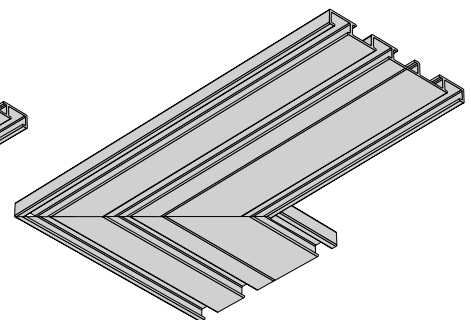

Model 4430

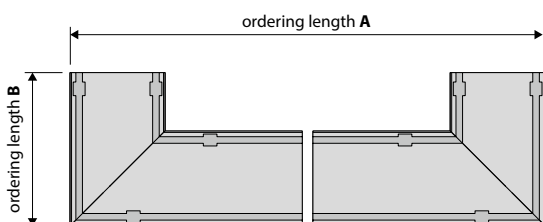

Mitre cut incl. 1 corner connector

Hand operated rail 4500

Aluminium rails

System 4500

RAIL 4520

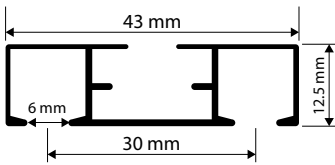

RAIL 4525

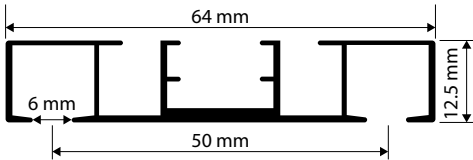

RAIL 4530

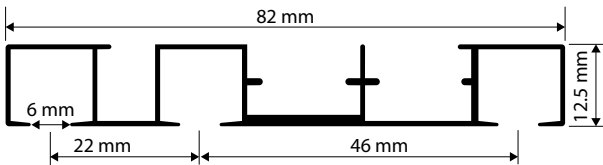

LOAD TABLE

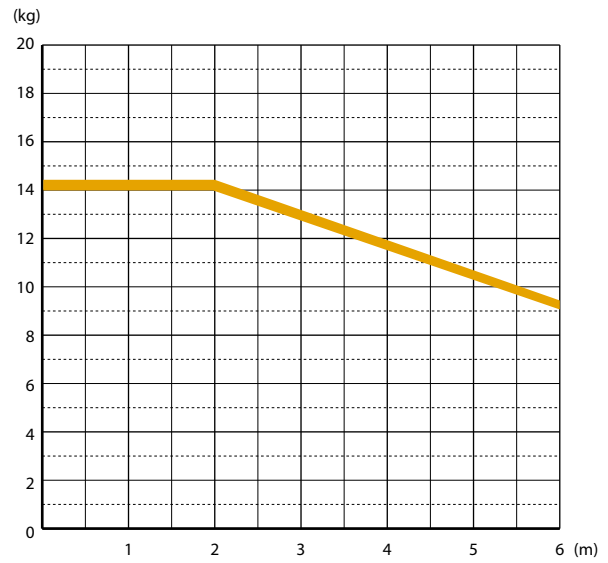

PRODUCT FEATURES

- Flat ceiling rail made of aluminium
- Suitable for objects
- Ceiling fixation
- Track width 6 mm
- Bearing length 6 m



Please use **rollers or object gliders** for heavy curtains.

AVAILABLE COLOURS



White (RAL 9016)



Silver (anodized)

STANDARD COMPONENTS



SELECTABLE GLIDERS



For the exact designation of standard components and gliders and for more gliders refer to **Accessories**.

ASSEMBLY OPTIONS

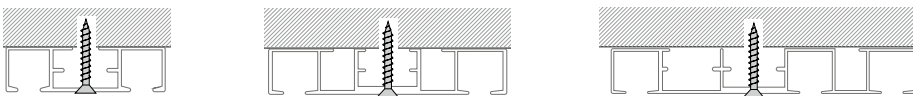

RETURN CURVE



Possible radii: **10 cm**
(please note curve type)

Hand operated rail 4500

Aluminium rails

RETURN CURVE

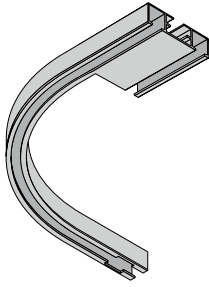

Model 4520

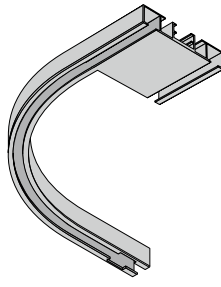

Model 4525

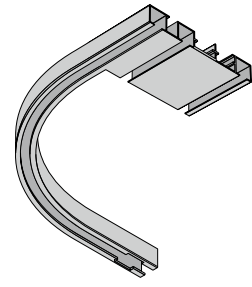

Model 4530

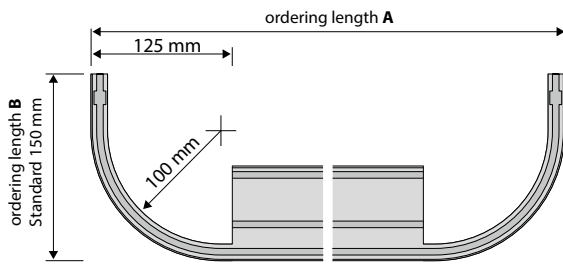

MITRE CUT

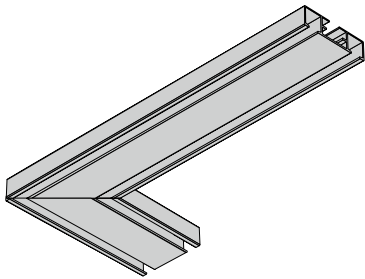

Model 4520

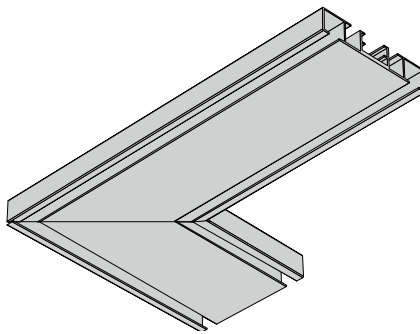

Model 4525

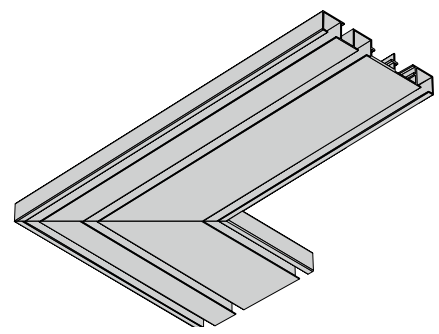

Model 4530

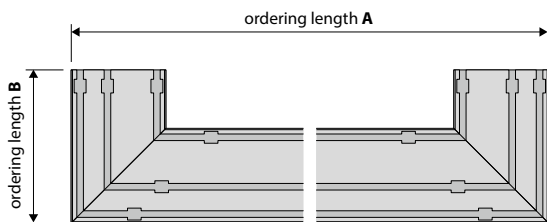

Hand operated rail 4600

Aluminium rails

System 4600

RAIL 4620

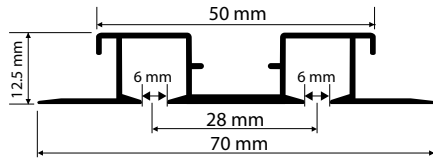

RAIL 4625

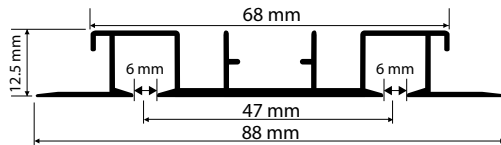

RAIL 4630

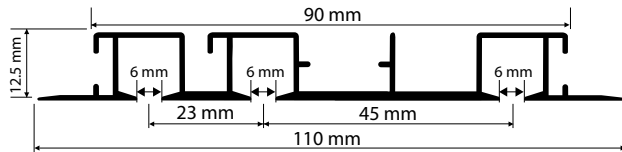

LOAD TABLE

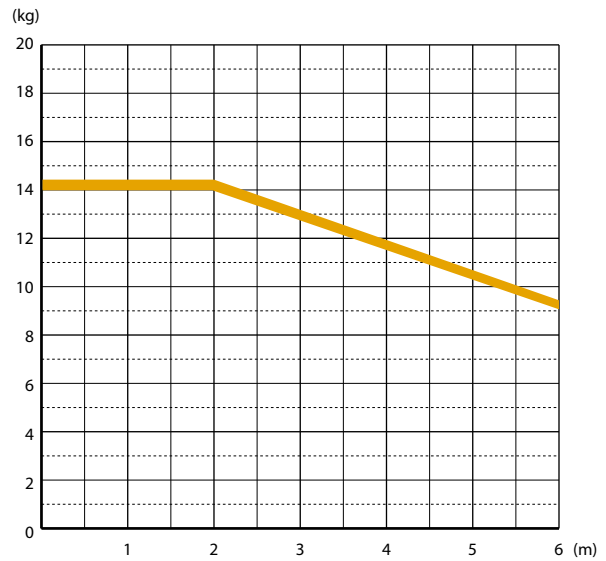

PRODUCT FEATURES

- Installation profile made of aluminium suitable for objects
- Installation at suspended ceilings
- Track width 6 mm
- Bearing length 6 m



Please use **rollers or object gliders** for heavy curtains.

AVAILABLE COLOURS



White (RAL 9016)

STANDARD COMPONENTS

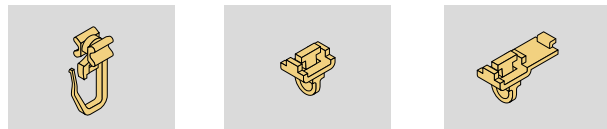

SELECTABLE GLIDERS



For the exact designation of standard components and gliders and for more gliders refer to **Accessories**.

ASSEMBLY OPTIONS

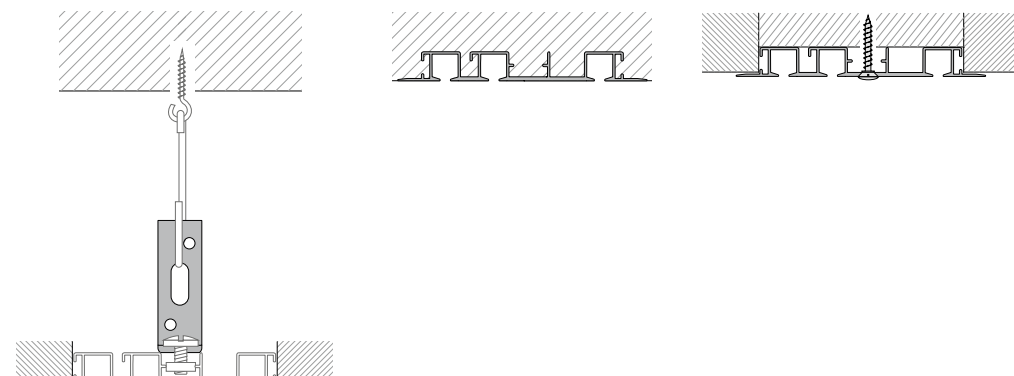

System 4850

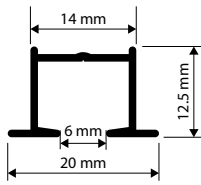

PRODUCT FEATURES

- Elegant slot profile for wooden substructure and plasterboard with min. 30 mm thickness
- Ceiling fixation
- Use of rollers possible
- Track width 6 mm
- Bearing length 6 m
- Predrilled every 15 cm

AVAILABLE COLOURS



White (RAL 9016)



Silver (anodized)

LOAD TABLE

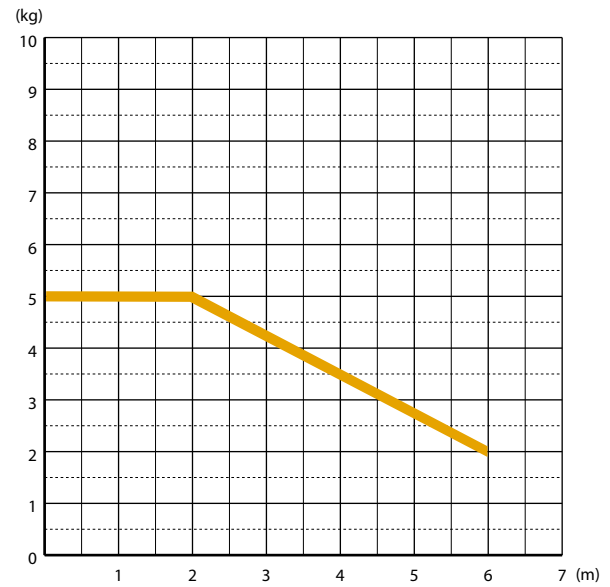

STANDARD COMPONENTS

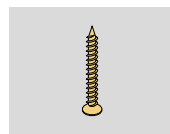
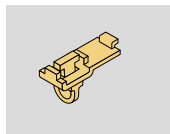
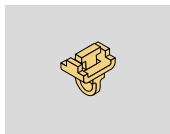
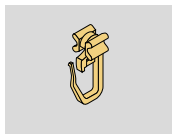

SELECTABLE GLIDERS

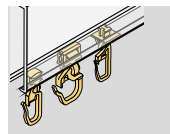
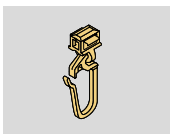

For the exact designation of standard components and gliders and for more gliders refer to **Accessories**.

ASSEMBLY OPTIONS

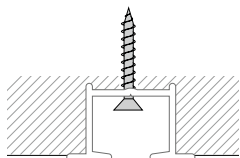

CURVE



Horizontal curve

Possible radii: **from 40 cm any radius possible**