

# Schleuderschiene 4400

Aluschienen

## System 4400

### SCHIENE 4410

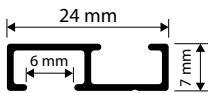

### SCHIENE 4420

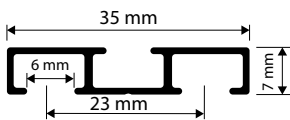

### SCHIENE 4425

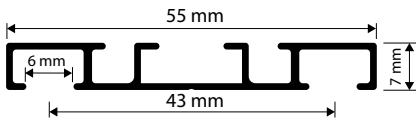

### SCHIENE 4430

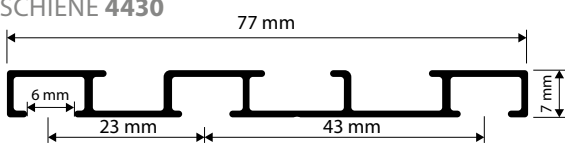

### BELASTUNGSTABELLE

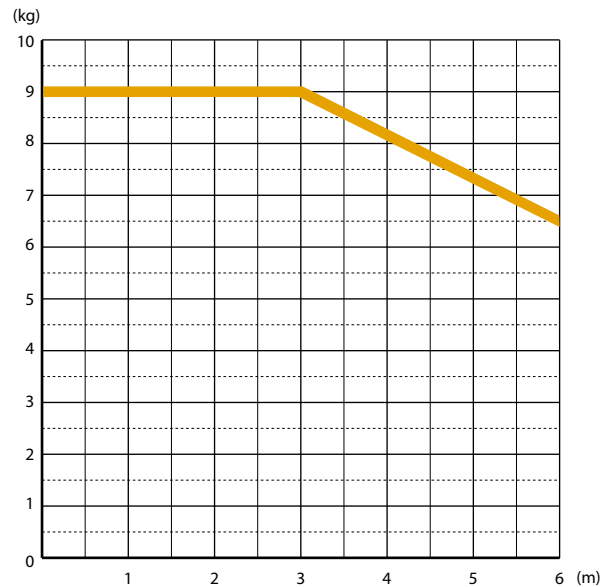

### PRODUKTMERKMALE

- sehr flaches Aluminiumprofil
- verschiedene Laufvarianten in gleicher Optik
- objektgeeignet
- für Deckenmontage
- Spurbreite 6 mm
- Lagerlänge 6 m



Bitte verwenden Sie bei schweren Vorhängen **Objektgleiter**.

### LIEFERBARE FARBEN



weiß (RAL 9016)



silber (eloxiert)

### STANDARDKOMPONENTEN

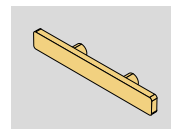
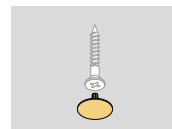
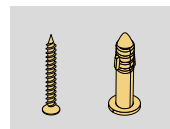
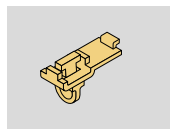
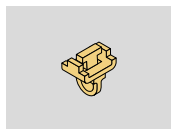

### GLEITER WÄHLBAR (ohne Aufpreis)

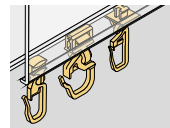
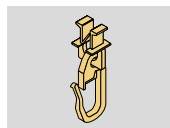

Genauere Bezeichnung von Standardkomponenten und Gleitern, sowie weitere Gleiter finden Sie unter **Zubehör**.

### MONTAGEMÖGLICHKEITEN

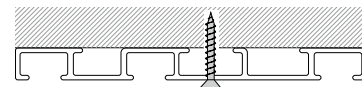
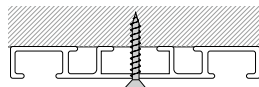
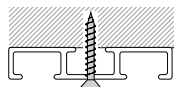
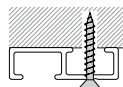

### RETOURENBIEGUNG



mögliche Radien: **10 cm, 15 cm** (bitte Biegeausführung beachten)

### BIEGUNG



horizontale Biegung

mögliche Radien: **10 cm, 15 cm, ab 40 cm** jeder Radius (bitte Biegeausführung beachten)



vertikale Biegung

für 4410 und 4420  
mögliche Radien: **20 cm, ab 40 cm** jeder Radius

# Schleuderschiene 4400

Aluschiene

## RETOURENBIEGUNG

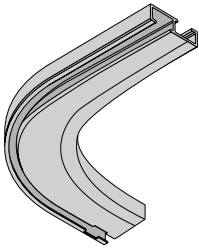

Modell 4410

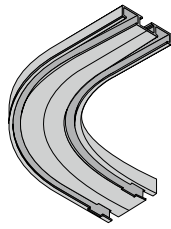

Modell 4420

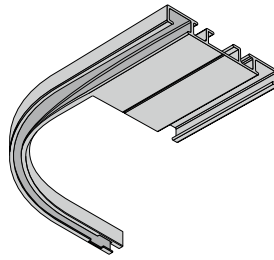

Modell 4425

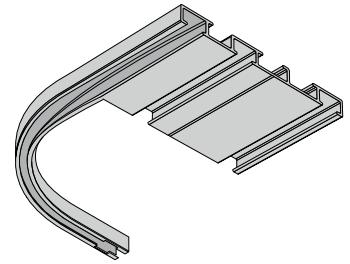

Modell 4430

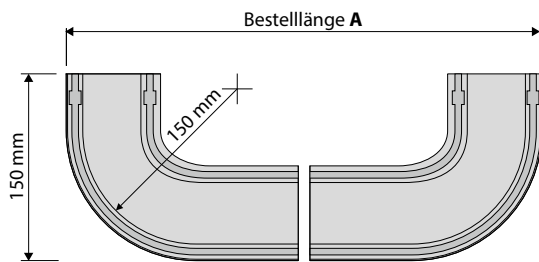

Retourenbiegung 4410/4420

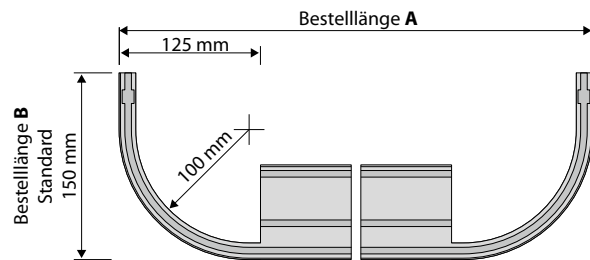

Retourenbiegung 4425/4430

## GEHRUNGSSCHNITT

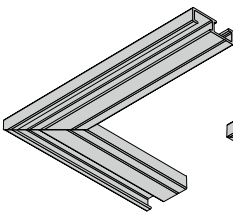

Modell 4410

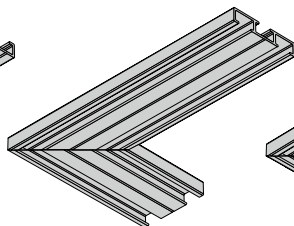

Modell 4420

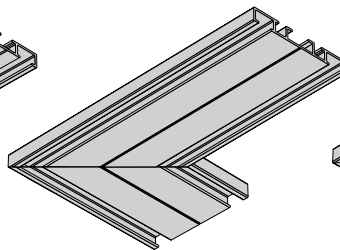

Modell 4425

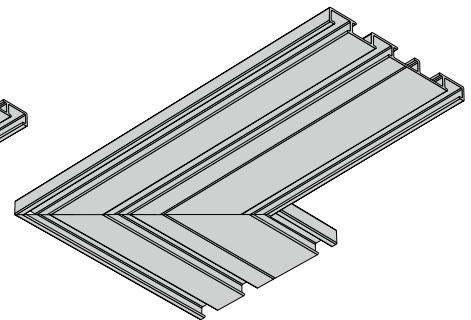

Modell 4430

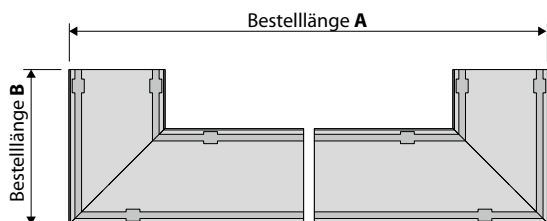

Gehrungsschnitt inkl. 1 Eckverbinder