

SR1, SR2

Montage- und Bedienanleitung

Assembly and operating instructions
Notice de montage et mode d'emploi

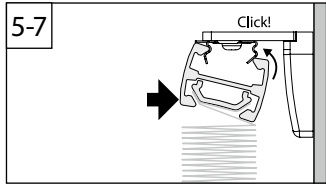
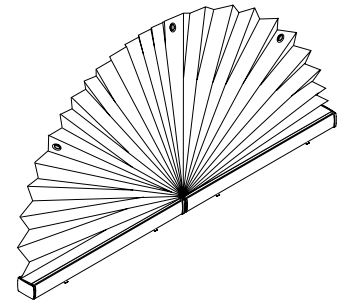

B Demontage

Dismantling – Démontage

FALZMONTAGE

TOP FIXING – DANS LA RAINURE

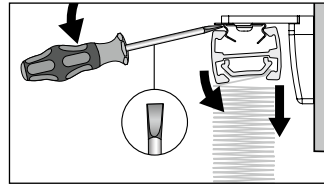

WANDWINKEL

WALL FIXING BRACKET – SUPPORT MURAL

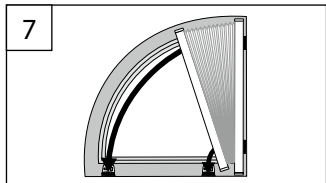
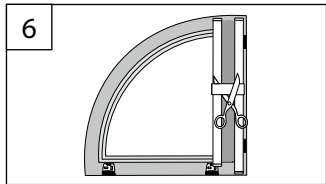
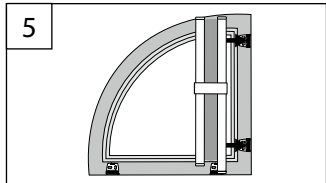
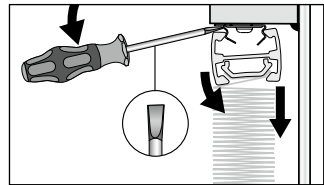

10 / 2021

technische Änderungen bleiben
vorbehalten

subject to technical change
sous réserve de modifications techniques



A Montage

Fixation – Montage

→ **Bitte nur beiliegende Schrauben verwenden!**

Please use only the enclosed screws! - Veuillez utiliser seulement les vis jointes!

FALZMONTAGE

TOP FIXING – DANS LA RAINURE

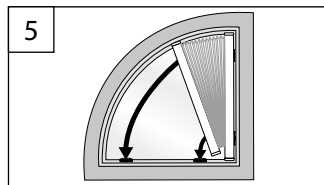
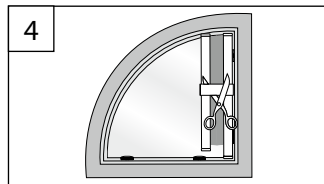
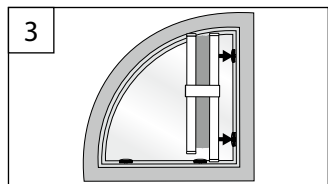
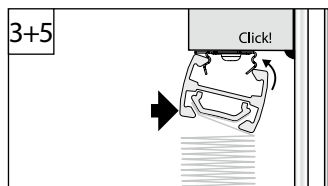
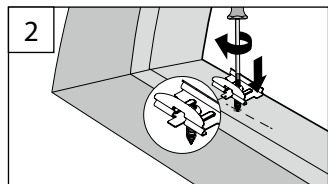
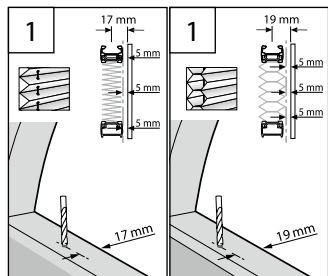
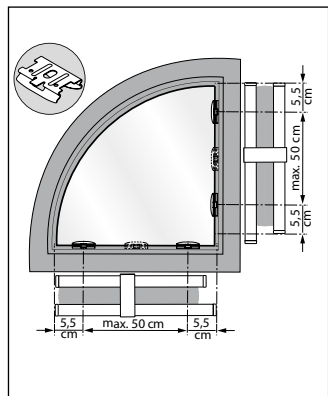

WANDWINKEL

WALL FIXING BRACKET – SUPPORT MURAL

