

Pull cord / turning cord

MZ 50 (slats 50 mm)

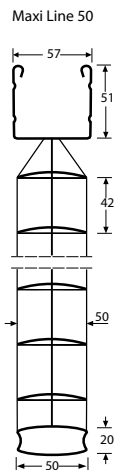
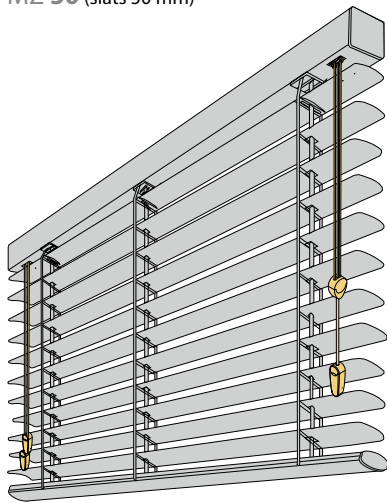

- Customization
- Slat width 50 mm
- Slat thickness 0.24 mm
- Free-hanging installation with fixed top profile and adjustable bottom profile
- Pull cord and turning cord
- Operating side left, right
- Operating side split (pull, turning cord left or right)
- Control length freely selectable
- Colour-matched top / bottom profiles
- Ladder cords available, width 25 mm
- Plastic parts transparent, colour-matched cords
- Pull and turning cord 3 mm
- Top fixation wall, ceiling brackets
- Cord guiding for an extra charge

RANGES OF SIZE

50 mm slats

Min. width	45 cm
Max. width	490 cm
Max. height	400 cm
Max. area	9 m ²

BUNCH HEIGHTS

50 mm slats

Installation height	Bunch height
100 cm	ca. 10.0 cm
150 cm	ca. 13.0 cm
200 cm	ca. 15.0 cm
250 cm	ca. 17.0 cm
300 cm	ca. 18.0 cm
350 cm	ca. 20.0 cm
400 cm	ca. 21.0 cm

50 mm slats with ladder cord

Installation height	Bunch height
100 cm	ca. 12.0 cm
150 cm	ca. 14.0 cm
200 cm	ca. 17.0 cm
250 cm	ca. 19.0 cm
300 cm	ca. 22.0 cm
350 cm	ca. 24.0 cm
400 cm	ca. 27.0 cm

OPERATION OPTIONS

left

right

split

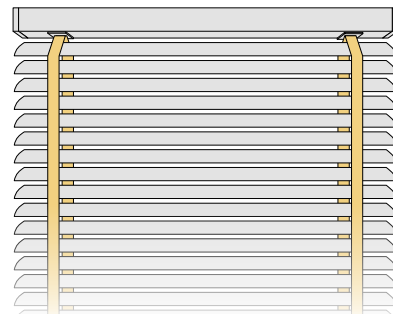
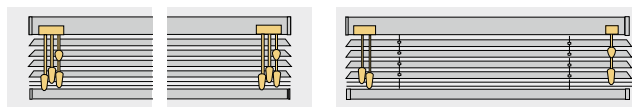

LADDER CORD COLOURS



Colour No. 040 black



Colour No. 210 white



Colour No. 110 mustard yellow



Colour No. 290 auburn



Colour No. 020 grey



Colour No. 190 cream



Colour No. 090 copper



Colour No. 060 brown

Maxi Line

Venetian blinds

Endless cord - front

MEV 50 (slats 50 mm)

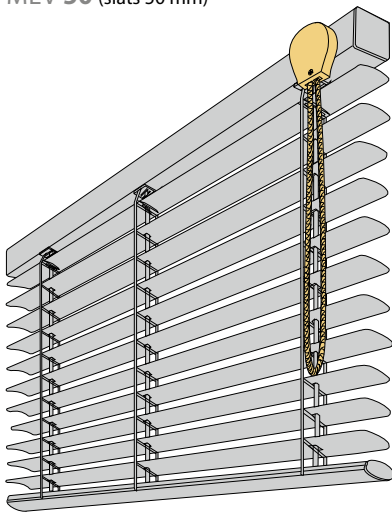

Maxi Line 50

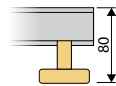
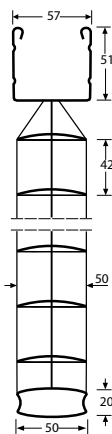

- Customization
- Slat width 50 mm
- Slat thickness 0.24 mm
- Free-hanging installation with fixed top profile and adjustable bottom profile
- Endless cord operation (cord exit - front)
- Gear 2.7 : 1, light grey
- Operating side left or right
- Control lengths 75, 100, 125, 150, 175, 200, 225, 250, 275, 300, 350, 400, 450, 500 cm
- Colour-matched top / bottom profiles
- Plastic parts transparent, colour-matched cords
- Pulling with 6 mm tex tape, white or light grey
- Top fixation wall, ceiling brackets
- Cord guiding for an extra charge

RANGES OF SIZE

50 mm slats

Min. width	60 cm
Max. width	490 cm
Max. height	500 cm
Max. area	10 m ²

BUNCH HEIGHTS

50 mm slats

Installation height	Bunch height
100 cm	ca. 10.0 cm
150 cm	ca. 13.0 cm
200 cm	ca. 15.0 cm
250 cm	ca. 17.0 cm
300 cm	ca. 18.0 cm
350 cm	ca. 20.0 cm
400 cm	ca. 21.0 cm

OPERATION OPTIONS

left

right

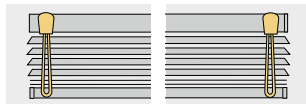

Endless cord at side

MES 50 (slats 50 mm)

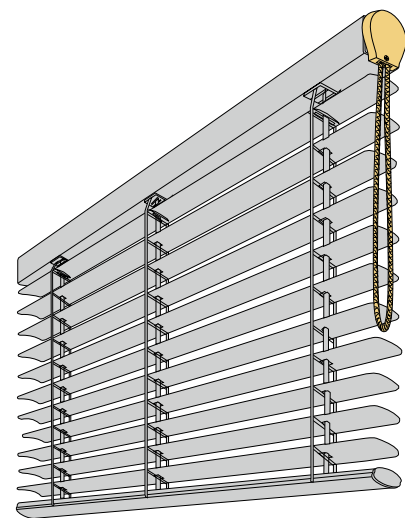

- Customization
- Slat width 50 mm
- Slat thickness 0.24 mm
- Free-hanging installation with fixed top profile and adjustable bottom profile
- Endless cord operation (cord exit - at side)
- Gear 2.6 : 1, light grey
- Operating side left or right
- Control lengths 75, 100, 125, 150, 175, 200, 225, 250, 275, 300, 350, 400, 450, 500 cm
- Colour-matched top / bottom profiles
- Plastic parts transparent, colour-matched cords
- Pulling with 6 mm tex tape, white or light grey
- Top fixation wall, ceiling brackets
- Cord guiding for an extra charge

RANGES OF SIZE

50 mm slats

Min. width	60 cm
Max. width	490 cm
Max. height	500 cm
Max. area	10 m ²

BUNCH HEIGHTS

50 mm slats

Installation height	Bunch height
100 cm	ca. 10.0 cm
150 cm	ca. 13.0 cm
200 cm	ca. 15.0 cm
250 cm	ca. 17.0 cm
300 cm	ca. 18.0 cm
350 cm	ca. 20.0 cm
400 cm	ca. 21.0 cm

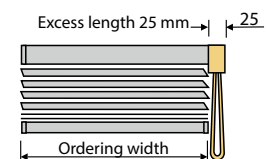

Note excess length of gear!

OPERATION OPTIONS

left

right

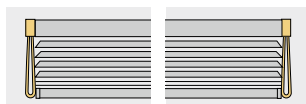

Crank

MKU 50 (slats 50 mm)

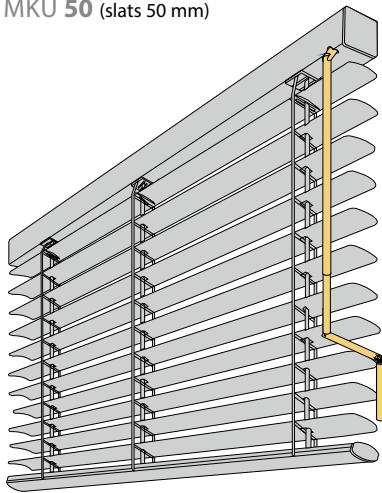

Maxi Line 50

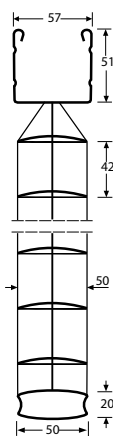

- Customization
- Slat width 50 mm
- Slat thickness 0.24 mm
- Free-hanging installation with fixed top profile and adjustable bottom profile
- Crank operation, removable crank for an extra charge
- Crank length as required max. 300 cm, silver
- Colour-matched top / bottom profiles
- Plastic parts transparent, colour-matched cords
- Pulling with 6 mm tex tape, white or light grey
- Top fixation wall, ceiling brackets
- Cord guiding for an extra charge

RANGES OF SIZE

50 mm slats

Min. width	60 cm
Max. width	490 cm
Max. height	500 cm
Max. area	10 m ²

BUNCH HEIGHTS

50 mm slats

Installation height	Bunch height
100 cm	ca. 10.0 cm
150 cm	ca. 13.0 cm
200 cm	ca. 15.0 cm
250 cm	ca. 17.0 cm
300 cm	ca. 18.0 cm
350 cm	ca. 20.0 cm
400 cm	ca. 21.0 cm

OPERATION OPTIONS

left right

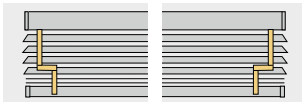

Motor 230 V

MAC 50 (slats 50 mm)

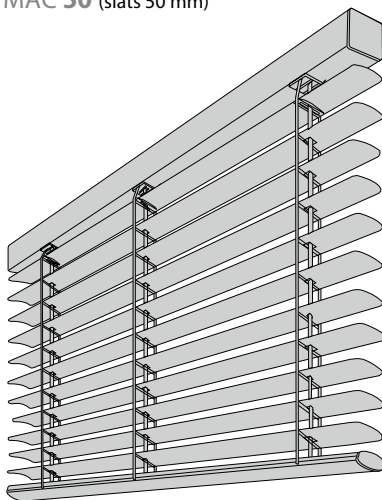

- Customization
- Slat width 50 mm
- Slat thickness 0.22 mm
- Free-hanging installation with fixed top profile and adjustable bottom profile
- Motor operation (motor inside the top profile)
- Cage motor 230 V, power consumption ca. 100 W, with integrated thermal protection and capacitor, protection class (IP44), easily accessible and exact limit switches, connection via premounted Hirschmann connector
- Cable exit left, centre or right (operation e.g. switch, radio, group control)
- Colour-matched top / bottom profiles
- Plastic parts transparent, colour-matched cords
- Pulling with 6 mm tex tape, white or light grey
- Top fixation with wall / ceiling fixing bracket with quick-lock
- Cord guiding for an extra charge

RANGES OF SIZE

50 mm slats

Min. width	60 cm
Max. width	490 cm
Max. height	500 cm
Max. area	18.0 m ²

BUNCH HEIGHTS

50 mm slats

Installation height	Bunch height
200 cm	ca. 17.0 cm
250 cm	ca. 19.0 cm
300 cm	ca. 20.0 cm
350 cm	ca. 22.0 cm
400 cm	ca. 24.0 cm

CABLE EXIT

left right



Maxi Line

Venetian blinds

Assembly instruction Wall and ceiling fixing brackets



Important! When you use the wall and ceiling fixing brackets with quick-lock for Maxi Line for ceiling fixation, a gap will form between the head rail and the ceiling.

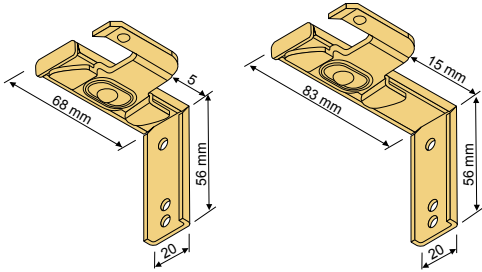

Wall / ceiling fixing bracket
with quick-lock

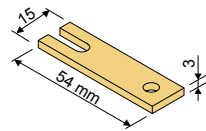

Distance disk for wall / ceiling fixing bracket
50 mm venetian blind

PULL CORD / TURNING CORD

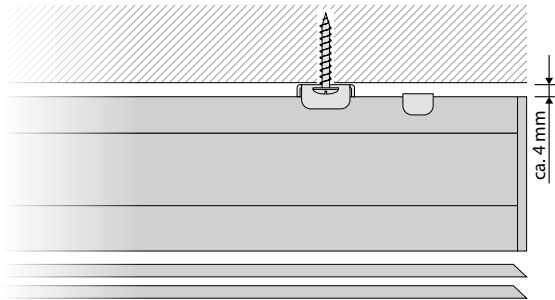

– ca. 4 mm gap between head rail and ceiling

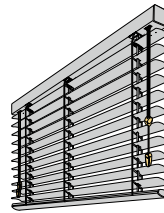

MZ 50

CRANK AND ENDLESS CORD FRONT AND AT SIDE

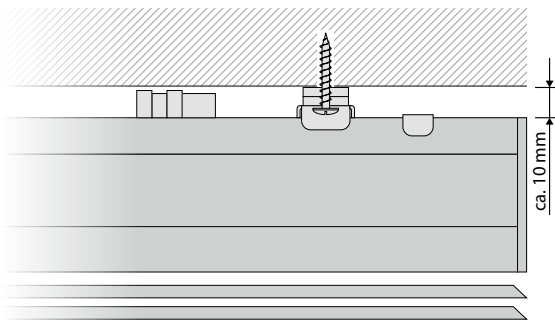

– ca. 10 mm gap between head rail and ceiling
– Due to the excess length of the tape/cord coils, two distance disks must be used per wall and ceiling fixing bracket (they are included in the scope of delivery)

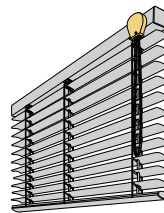

MEV 50

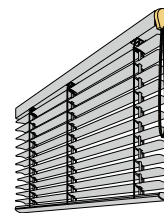

MES 50

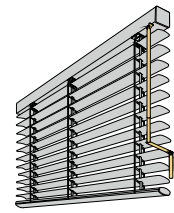

MKU 50

MOTOR

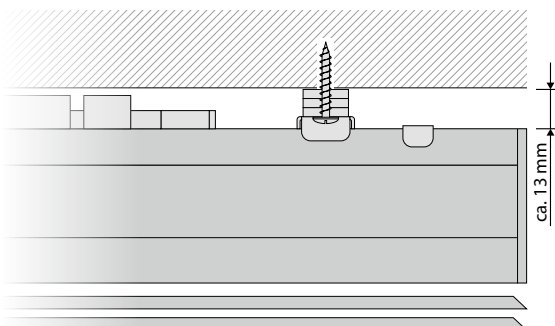

– ca. 13 mm gap between head rail and ceiling
– Due to the excess length of the tape/cord coils and of the motor, three distance disks must be used per wall and ceiling fixing bracket (they are included in the scope of delivery)

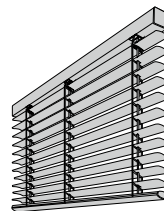

MAC 50